



Starway

ДАУТОНА



MANUEL DE L'UTILISATEUR USER MANUAL

Table des matières

Spécifications Techniques	3
Introduction	3
Dimensions	3
Réglementation	4
Garantie applicable en France	4
Consignes de sécurité	4
Spectrométrie	6
Raccordement DMX	9
Architecture des menus	10
Agencement des Pixels.....	16
Affectation des canaux	17
Roue de couleurs virtuelle	37
Patterns	38

ENGLISH VERSION 43



SPÉCIFICATIONS TECHNIQUES :

- Zoom 5° - 52°
- Eclairage : 51 500 Lux à 5M/5°
- Flux max 11632 Lumens
- Refroidissement : Air forcé 3 modes
- Modes DMX : 17/21/25/63/163ch
- Protocoles : DMX/Artnet/sACN/Klingnet/RDM
- 30 programmes internes de patterns
- BColor System
- Flicker Free : Fréquence des leds ajustable de 900HZ à 25000Hz
- Dmx In/Out connecteurs: 2 x XLR5.
- Artnet/ sACN/Klingnet connecteurs: 2 x RJ45
- Dimensions L x P x H : 399MM * 255MM * 406MM
- Poids net : 19Kg avec Omega d'accroche .
- Puissance max : 935W

Introduction :

Ce produit a été dédié à une utilisation en intérieur exclusivement. Particulièrement adapté pour les scènes. Plateau TV ou discothèques. Contrôlables en DMX ces projecteurs pourront être contrôlés par n'importe quelle console DMX.

DIMENSIONS (mm) :

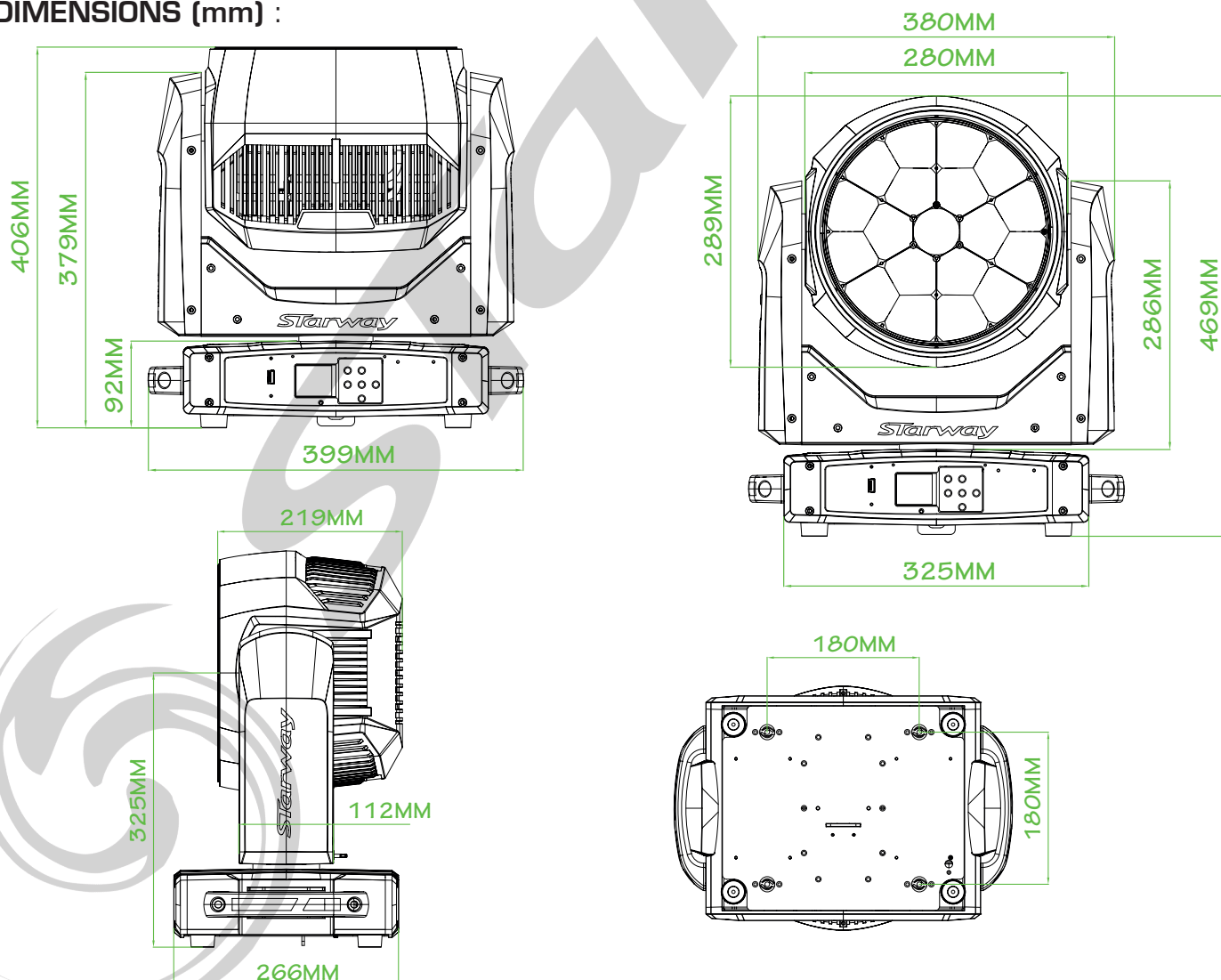

Réglementation

Cet appareil est parfaitement conçu. Il répond aux dispositions réglementaires actuelles : CE, ROHS, R&TTE

Recyclage

Appareil soumis à la DEEE (Collecte sélective). Contribuez à la protection de l'environnement en éliminant les matériaux d'emballage de ce produit via les filières de recyclage appropriées. Recyclez ce produit via une filière DEEE (déchets d'équipements électroniques). Ce produit doit être repris par votre revendeur ou doit être déposé dans un centre de collecte spécifique (déchetterie).

Garantie applicable en France

Le fabricant a apporté le plus grand soin à la conception et à la fabrication de votre produit pour qu'il vous apporte entière satisfaction. Néanmoins, s'il apparaissait que votre produit était défectueux, vous bénéficiez d'une garantie commerciale de 24 mois à compter de la date d'achat. Pour mettre en œuvre cette garantie, l'utilisateur doit présenter le produit au distributeur, accompagné du ticket de caisse ou la facture d'achat accompagnée du numéro de série.

Cette garantie, applicable en France, couvre tous les défauts du produit qui ne permettent pas une utilisation normale du produit. Elle ne couvre pas les défauts liés à un mauvais entretien, une utilisation inappropriée, une usure prévisible ; ou si les recommandations du fabricant n'ont pas été respectées.

La garantie ne couvre pas l'usure normale des pièces liée à l'utilisation du produit, tel que Batterie, Lampe, Roues, pièces d'usures, etc...

Eu égard au défaut et à la pièce concernée, le garant décidera alors de procéder à la réparation ou au remplacement de ladite pièce.

Le garant est : **CSI AUDIOVISUEL - 22 Rue Edouard Buffard - 75144 Montevrain - 01.48.63.22.11.**

La durée de fourniture de pièces détachées est de deux ans.

La garantie commerciale prévue ci-dessus ne limite aucunement le droit de l'acheteur d'agir en garantie des vices cachés ou de non-conformité, tel que prévu aux codes civil et de la consommation Française.

Consignes de sécurité

VEUILLEZ LIRE ATTENTIVEMENT ET CONSERVEZ CE MANUEL

Toute personne impliquée dans l'installation, l'utilisation et la maintenance de cet appareil doit être qualifiée et suivre les instructions comprises dans ce manuel.

Soyez prudent risques de chocs électriques !

Avant la mise en fonction, soyez certain que le produit n'ait pas subi de dommage durant le transport. Dans le cas contraire, contactez votre revendeur.

Afin de maintenir l'appareil en parfaites conditions, l'utilisateur doit suivre les instructions de sécurité et d'utilisation décrites dans ce présent document.

Notez que les dysfonctionnements liés à la modification de l'appareil ne sont pas couverts par la garantie.

Cet appareil ne contient aucune partie remplaçable par l'utilisateur, pour toute intervention contactez votre revendeur.



Soyez prudent risque photo-biologique !
Attention !! Système d'éclairage professionnel
ne pas regarder le flux lumineux dans l'axe.



Risque d'incendie maintenir une distance minimale de 0,8 m entre le faisceau et une surface inflammable.

IMPORTANT :

Cet appareil doit être utilisé en intérieur avec une température ambiante inférieure à 40°. Fixer le projecteur d'une façon stable.

Ne pas faire cheminer le câble d'alimentation avec les autres câbles.

Manipuler le câble d'alimentation avec les précautions d'usage.

Ne pas insérer d'objets dans les aérations.

Ne pas démonter ou modifier l'appareil. Risque d'électrocution !

Ne pas connecter cet appareil à un bloc de puissance.

Ne pas mettre En / Hors fonction de manière répétée.

Cet appareil doit être relié à la terre

N'utiliser cet appareil qu'après vous être familiarisé avec ses commandes et fonctions.

Éviter tout contact avec les flammes, éloignez l'appareil des surfaces inflammables.

Laisser toujours un espace suffisant autour de l'appareil pour permettre sa convection.

Déconnecter l'appareil du secteur, lorsqu'il n'est pas utilisé ou avant de le nettoyer.

Toujours débrancher l'alimentation en tenant la prise secteur et non le câble.

Vérifier que le cordon d'alimentation ne soit ni pincé ni endommagé, (prises et câbles)

Si l'appareil est tombé ou à reçu un choc, déconnecter le immédiatement du secteur et contacter un technicien qualifié pour le vérifier.

Si l'appareil a été soumis à d'importantes fluctuations de température, ne le mettez pas en fonction immédiatement, la condensation pourrait l'endommager en créant un CC (court-circuit).

Si l'appareil ne fonctionne pas correctement, mettez-le hors fonction immédiatement. Emballer-le, (de préférence dans son emballage d'origine).

Ce produit doit être utilisé exclusivement par un adulte en bonne santé.

Il doit être installé hors de portée des enfants.

Ne jamais utiliser le produit sans surveillance.

Ne pas utiliser l'appareil dans des zones ATEX ou et à proximité de d'hydrocarbure ou de produit inflammable.

Cet appareil doit être utilisé conformément à ce manuel, pour éviter tous dysfonctionnement

Nettoyage

Penser à nettoyer régulièrement l'optique avec un chiffon micro-pore.

L'usage d'air comprimé permet de nettoyer le boîtier.

**Le projecteur doit être sécurisé
par une élingue de sécurité**



SPECTROMÉTRIE

Distance 5 mètres		
Couleur	Longueur d'onde	Lux
Rouge	637 nm	8377 lux
Vert	516 nm	15521 lux
Bleu	443 nm	4112 lux
Blanc		25146 lux
LEDs RGBW 5°		51500 lux
LEDs RGBW 52°		1691 lux

MESURES EFFECTUÉES AVEC *USPECTRUM MK305S*

LED ROUGE

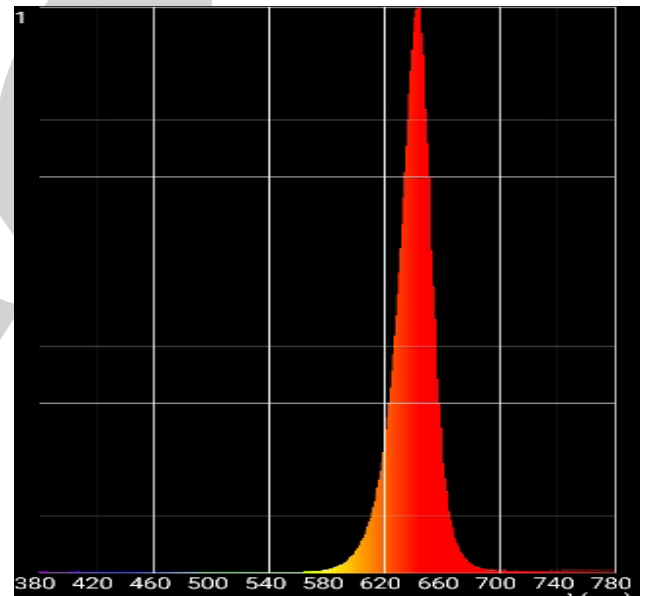
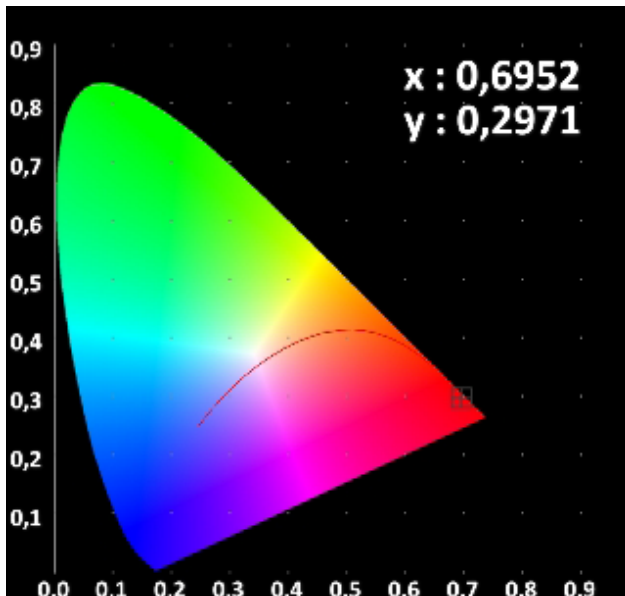

LED VERTE

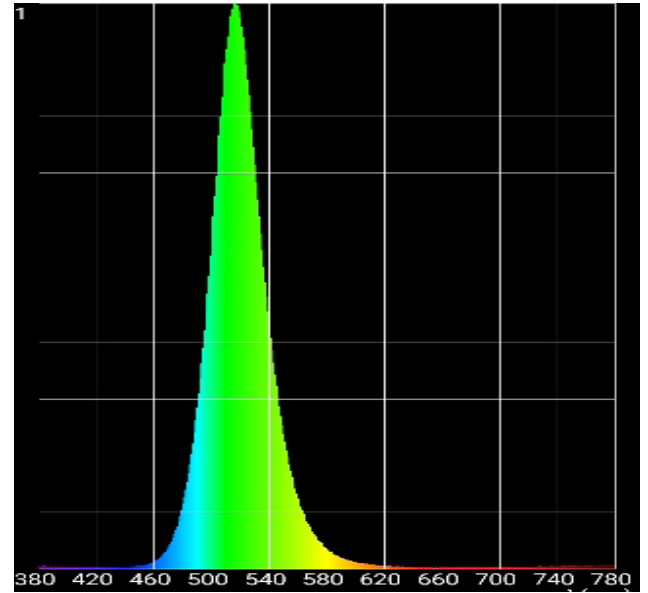
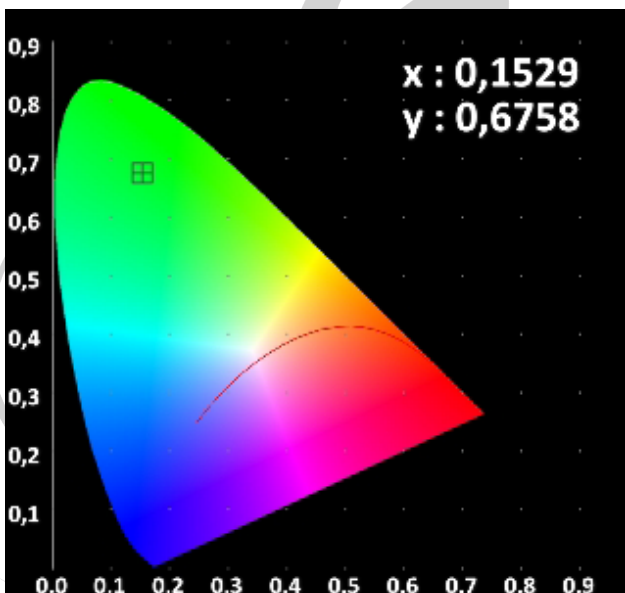

LED BLEU

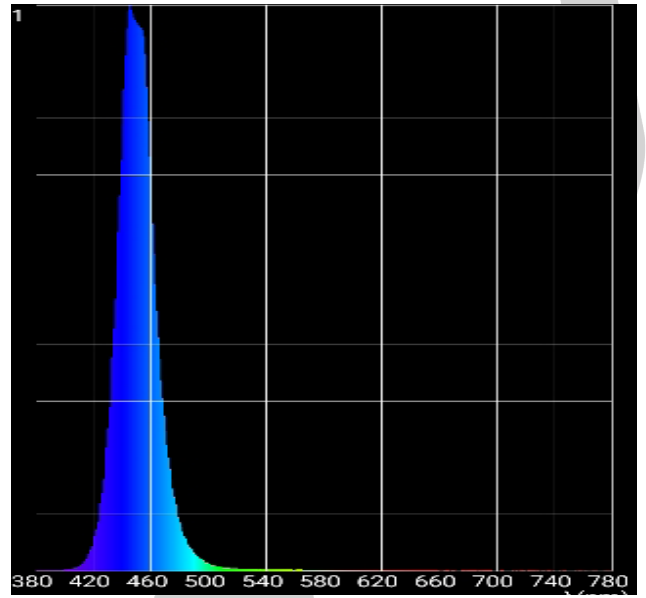
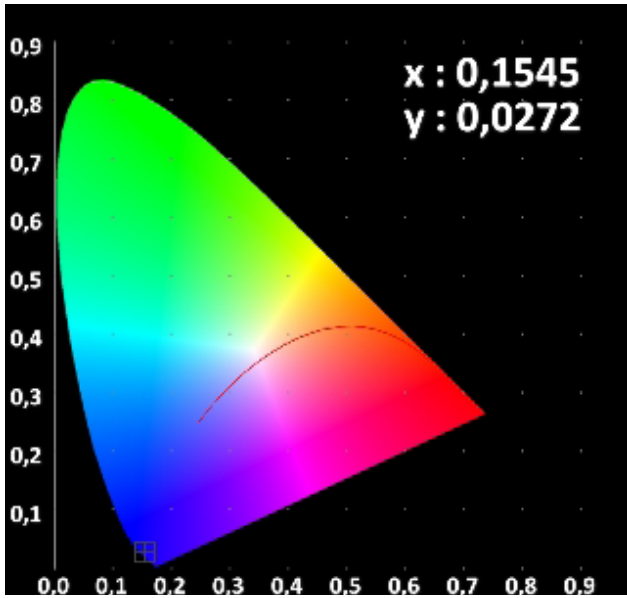

LED BLANCHES

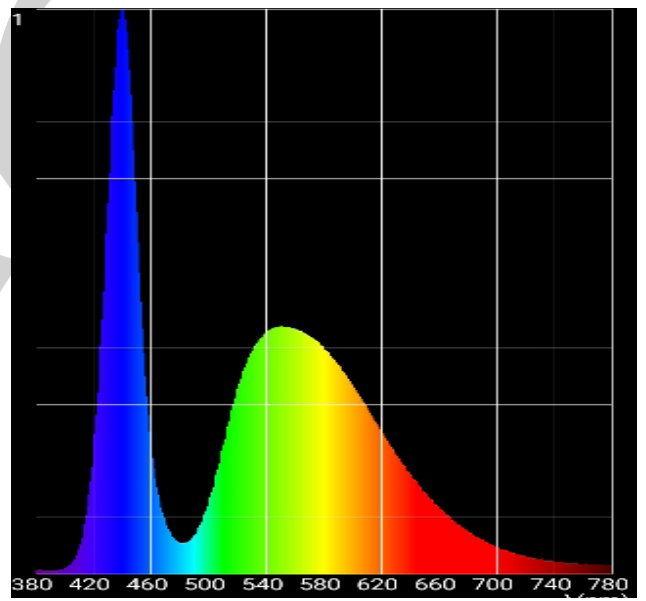
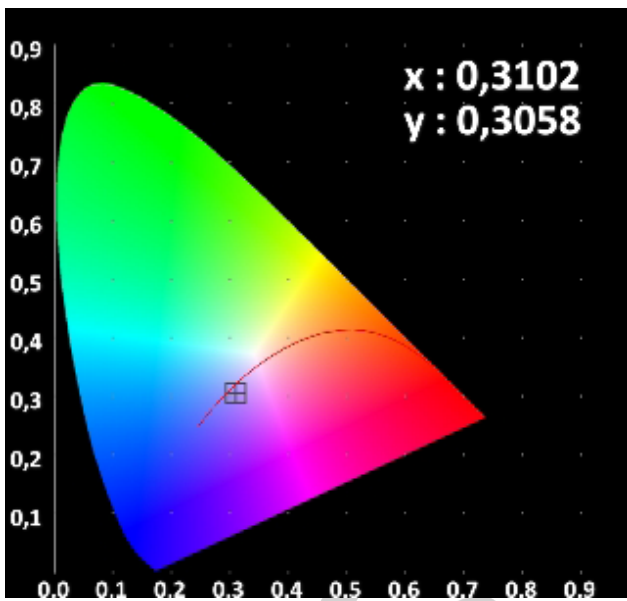

Angle d'ouverture mini

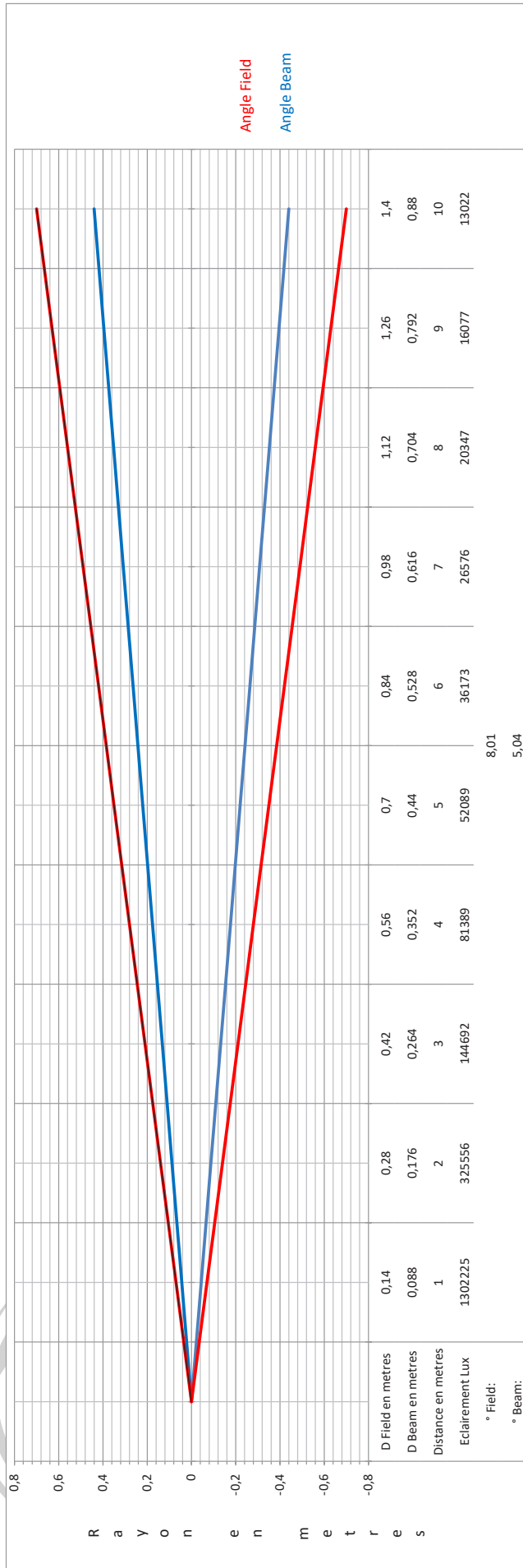

Angle d'ouverture maxi

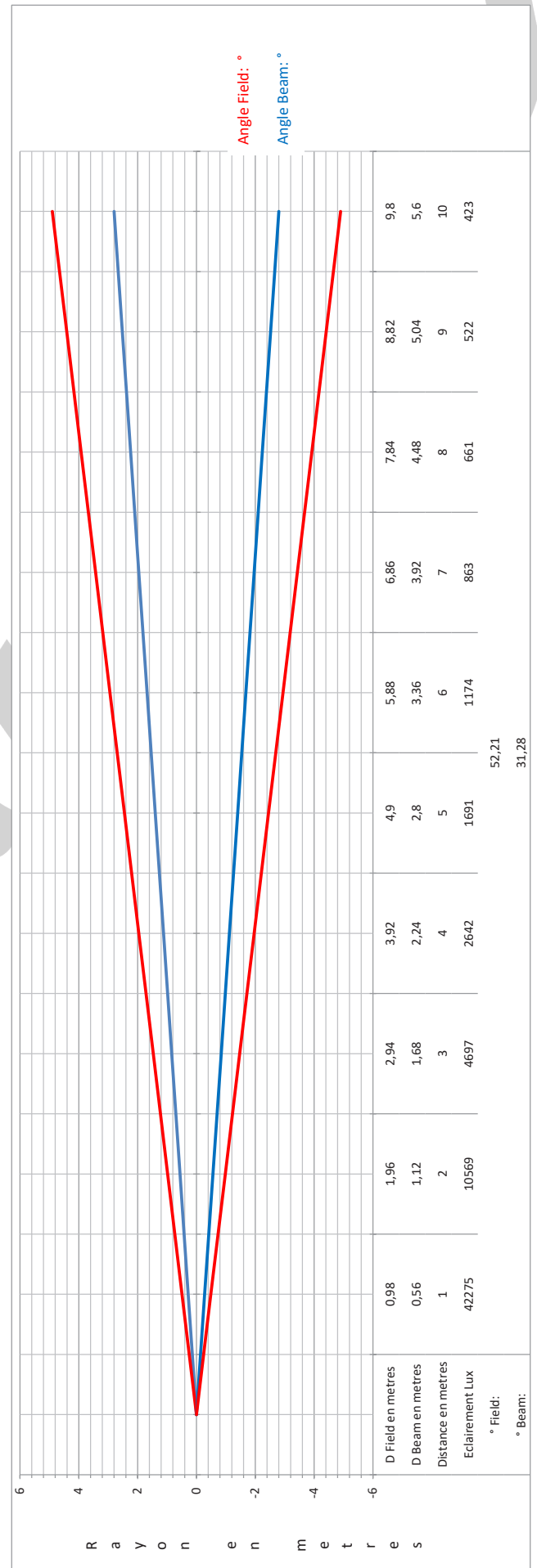

RACCORDEMENT DMX:

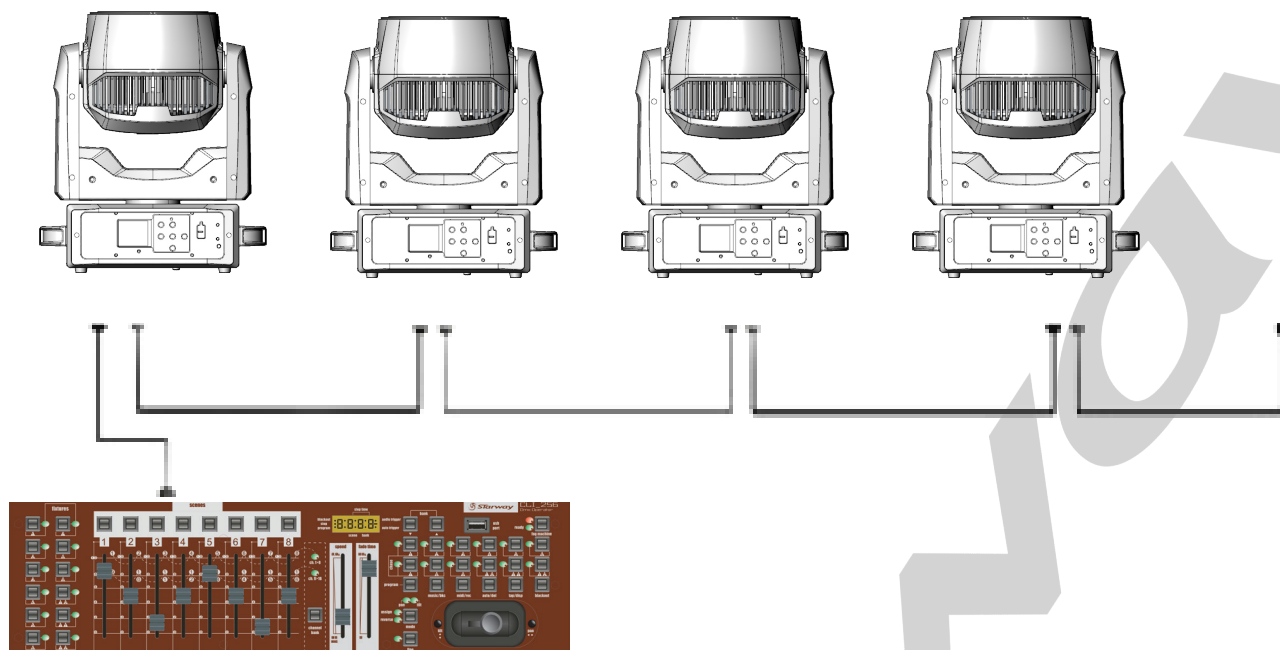

Les projecteurs sont connectés en série à une console DMX.

Raccorder les projecteurs comme le montre le schéma ci-dessus.

- Raccorder le côté mâle du câble DMX à la sortie de la console DMX512.
- Puis connecter la sortie DMX du projecteur à l'entrée du projecteur suivant.
- Répéter l'opération sur l'ensemble de la chaîne.

L'utilisation d'un bouchon de terminaison est vivement conseillée. Dans certains cas l'absence de cette terminaison n'est pas problématique, Par contre sa présence est très vivement conseillée dans des espaces perturbés (Scène, grandes longueur de ligne, studio TV etc.). Sa valeur est généralement de 120 Ohms Le bouchon est une prise XLR mâle dans laquelle est soudé entre 2 et 3 une résistance de 120 Ohms ¼ de W. Ce bouchon évite la réflexion des informations transmises lors de l'utilisation de grandes longueurs de câbles.

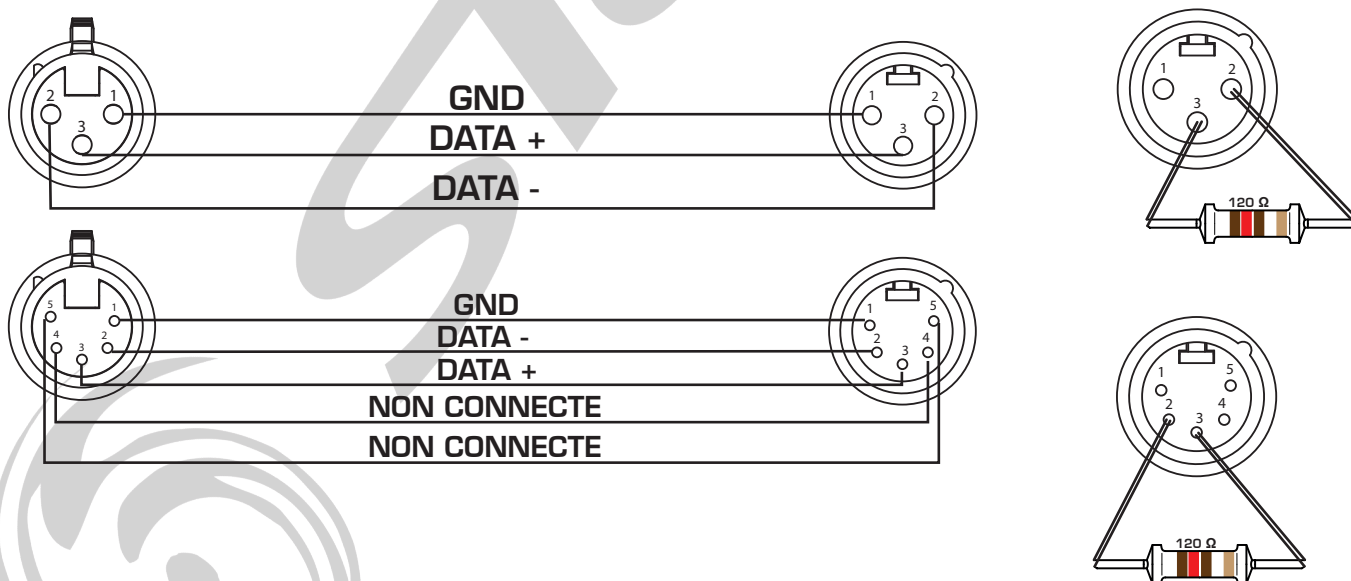

Architecture des menus

LES VALEURS EN **ROUGES** SONT DÉFINIES PAR DÉFAUT DANS LE MENU ET RECHARGÉES TELLES QUE EN CAS DE «RECHARGEMENT DES PARAMÈTRES PAR DÉFAUT»

Receive	Adress mode	1 address	Mode 1 adresse
		2 address	Mode 2 adresses
	Set Address	Adress Fixture	A001~AXXX
		Address Leds	A001~AXXX
User Mode	User Mode	Basic 8B	
		Basic 16B	
		Standard 8B	
		Standard 16B	
		Pixel 8B	
		Pixel 16B	
		User A	
		User B	
	User C		
	Edit A	Max Chan PAN, TILT, .../...	
	Edit B		
Edit C			
Function	Status	No DMX Mode	Hold /Auto/black
		Zoom Park	ON /OFF
		P.Reverse	ON/ OFF
		T.Reverse	ON/ OFF
		Pan Degree	630/ 540
		Feedback	ON /OFF
		Move.Spd	Speed 1 ~ 4
		Hibernation	OFF , 01M~99M, 15M
	Fixture ID	ServicePIN	000-255 (050)
		Universe	000-255
		UnitIPAddr	002.000.000.002
		Mask Addr	255.000.000.000
	Protocol Set	ArtNet	
		sACN	
	KlingNet	Enable /Disable	
	Net Switch	On /Off	
	Dim Mode	Standard /Stage/TV/Architectural/Theatre	
	Temp. C/F	Celsius	
		Fahrenheit	
	Dim Curve	LINEAR	
		Square	
		Exp	
		Log	
		S-CURVE	

Function (Suite)	Frequency	900HZ/1000HZ/1100HZ/1200HZ/1300HZ/ 1400HZ/1500HZ/2500HZ/4000HZ/5000HZ/ 10KHZ/15KHZ/20KHZ/25KHZ			
	Fan Set	Head Fan	Auto		
			High		
			Silent		
	LCD.Set	Backlight	02~60m <05m>		
		FlipDisplay	ON/OFF		
		Key Lock	ON/OFF		
		DispFlash	ON/OFF		
	Disp.Set	Chan.Value	PAN, TILT,		
		Slave Set	Slave1, Slave2, Slave3		
		Auto.Prog	Master / Alone		
	DFSE	ON/OFF			
	USB Update	ON/OFF			
	Wireless	W-DMX	ON/OFF		
		Tx/Rx	Transmit / Receive		
Protocol		G3 / G4S			
Tx/Rx Link		Link / UnLink			
Rx Reset		NO/YES			
Information	Time.Info	CurrentTime	(Hours)		
		Total Time	(Hours)		
		Last Time	(Hours)		
		Timer PIN	Clear last Password=050, Clear total Password=060		
			Clear Last	ON/OFF	
	Clear Total				
	Temp. Info	XXXF			
	Fan Speed	Fan : xxxxRPM			
	Error. Info	NONE/Pan,Tilt.....			
	Model. Info	MODENA			
Software.Ver- sion	1U01 Vx.x.x 2U01 Vx.x.x 3U01 Vx.x.x 4U01 Vx.x.x 5U01 Vx.x.x 6U01 Vx.x.x				

Test	Reset.Motor	All
		Pan&Tilt
		Head
	Test.Channel	PAN, TILT,
	Panel.Ctrl.	PAN =XXX
		TILT=XXX
		.../...
	Calibrate	Password – 050
		PAN
		TILT
		.../...

MENU RECEIVE

Adress Mode :

Pour faciliter la conception de matrices de leds avec des systèmes de gestion DMX d'entrée de gamme, il est possible d'adresser le Daytona de manière classique (tous les canaux sont adressés de manière contiguë), ou de sélectionner une première adresse pour les paramètres généraux du projecteur et une seconde pour la matrice de LEDs.

Set Adress :

Configuration de l'adresse DMX du Daytona

MENU USER MODE

User Mode :

Sélection du mode DMX du Daytona entre les différents modes tels que :

- Basic 8B - 17 canaux DMX - Leds Mode 8 Bits
- Basic 16B - 21 canaux DMX - Leds Mode 16 Bits
- Standard 8B - 21 Canaux DMX - Leds Mode 8 Bits
- Standard 16B - 25 Canaux DMX - Leds Mode 16 Bits
- Pixel 8B - 93 Canaux DMX - Leds pixel/pixels 8 Bits
- Pixel 16B - 153 Canaux DMX - Leds pixel/pixels 16 Bits
- User A - Mode utilisateur 1
- User B - Mode utilisateur 2
- User C - Mode utilisateur 3

Edit A ; Edit B ; Edit C

Dans ce sous menu il est possible de créer 3 affectations de canaux à discrétion de l'utilisateur. Dans chaque sous-menu «Edit A ; Edit B et Edit C» il est possible de sélectionner le nombre de canaux maximum, et de changer l'ordre des canaux DMX.

MENU FUNCTION

Status

Dans ce sous-menu il est possible de modifier le comportement du Daytona.

No DMX Mode : Modification de la réaction du Daytona lors de la perte de signal DMX :

- Hold : maintien des dernières valeurs DMX reçues
- Auto : Le Daytona passe en mode Auto
- Black : Le Daytona passe en mode «Stand By»

P Reverse : ON/OFF - Inversion du Pan

T Reverse : ON/OFF - Inversion du Tilt

PAN degree : 630° Ou 540° - Sélection du maximum d'angle de PAN

Feedback : ON/OFF - Activation ou Désactivation du retour d'information des moteurs (Recopie)

Move Speed : Sélection de la vitesse des mouvements entre 1 et 4
1 - plus rapide à 4 - moins rapide

Hibernation

En cas d'absence de signal, le projecteur passera en mode veille jusqu'au retour du signal :
OFF - 01 Min à 99 Min - Sélection du mode d'hibernation du Daytona.
OFF par défaut ou de 1 minute à 99 minutes avant le passage en mode hibernation.

Fixture ID

Sous-menu permettant la modification de l'Univers DMX de réception (ArtNet et sACN) ainsi que l'adresse IP et le masque de sous-réseau du Daytona. Pour déverrouiller à ce menu entrer le **Code Pin : 050**

Universe : 0-255 - Sélection de l'univers DMX de réception
UnitIPAddr : xxx.xxx.xxx.xxx - Sélection de l'adresse IP du Daytona
MaskAddr : xxx.xxx.xxx.xxx - Sélection du masque de sous-réseau du Daytona

Protocol Set

Sous-menu permettant la sélection du protocole réseau du Daytona :
Artnet (par défaut) ou sACN

KlingNet

Sous-menu permettant l'activation ou non du protocole KlingNet :
Enable (par défaut) ou Disable

Net Switch

Sous-menu permettant l'activation ou la désactivation du switch Ethernet du Daytona.

Dim Speed

Sous-menu permettant le choix de lissage du dimmer entre Standard (par défaut) , Stage, TV, Architectural ou Theatre.

Temp C°/F°

Sous-menu permettant de sélection du système Celsius (par défaut) ou Fahrenheit, pour l'affichage de la température.

Dim Curve

Sous-menu permettant la sélection de la courbe du dimmer entre Linear (par défaut), Square, Exp, Log et S-Curve

Frequen

Sous-menu permettant la sélection de la fréquence de rafraîchissement de la LED pour éviter un éventuel «flicking» à la captation. Valeur modifiables entre 900Hz (par défaut) et 25Khz.

Fan Set - Head Fan

Sous-menu permettant de sélectionner la vitesse du ventilateur de la tête entre Auto (par défaut) et Low ou High.

LCD Set

Sous-menu permettant de sélectionner le comportement de l'afficheur du Daytona.

Backlight - 02m à 60m - Sélection du temps de maintien du rétro éclairage de l'afficheur (sans manipulation du menu) de 2 minutes à 60 minutes. Temps réglé sur 5 minutes par défaut.

Flip Display - ON/OFF - Inversion du sens de l'afficheur

KeyLock - ON/OFF - Verrouillage des boutons du Daytona.

DispFlash - ON/OFF - Validation ou non du flash de l'afficheur lorsque le Daytona ne reçoit pas de signal DMX.

Disp.Set

Chan.Value - affichage en continu des valeurs DMX de tous les canaux.

Slave Set - Sélection du mode esclave du Daytona pour «décaler» les Daytona lors de l'utilisation du mode Maître/Esclave - entre Slave 1, Slave2 et Slave 3.

Auto Prog - Sélection du mode Maître/Esclave :

En mode MASTER Le Daytona transmet les informations aux Daytona connectés à l'aide d'un câble DMX et où le mode Esclave a été activé dans le sous-menu «Slave Set»

En mode ALONE le Daytona ne transmet pas les information et exécute son mode AUTO de manière individuelle.

DFSE - ON/OFF - Rechargement des paramètres par défaut du Daytona.

USB Update - ON/OFF - Mise à jour du firmware du Daytona

PROCÉDURE MISE A JOUR DES FIRMWARE PAR CLÉ USB :

1. Placer les fichiers de mise à jour dans un répertoire sur la clef USB par exemple pour le Daytona :

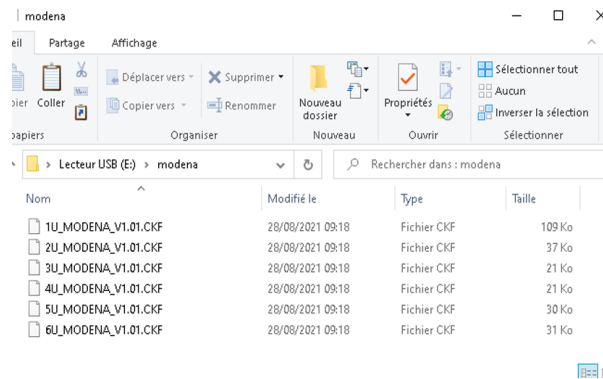

2. Allumer le projecteur et aller dans le menu en pressant « Mode » > « Fonction » > « USB Update » > « On », sortir du menu et éteindre la machine.
3. Machine éteinte, DMX et ARTnet débranchés, insérer la clef dans le connecteur en face avant.
4. Allumer le projecteur > l'écran affiche les répertoires disponibles > sélectionner « Daytona »

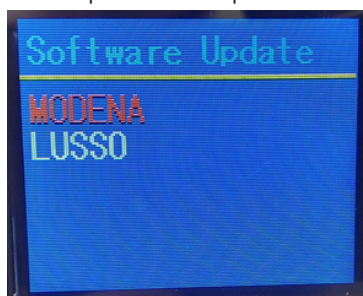

5. Sélectionner « Start » et appuyer sur « Enter »

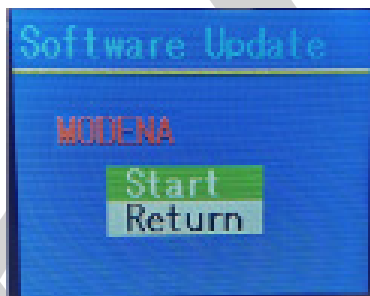

6. Le processus de mise à jour démarre et programmera chaque carte électronique. Le projecteur effectuera un reset à la fin du processus

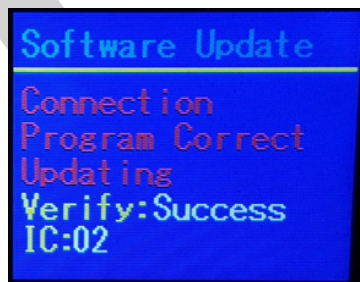

7. Retirer la clé et vérifier les versions de software en pressant «Mode» > «Information» > «Software. V» > «Enter»

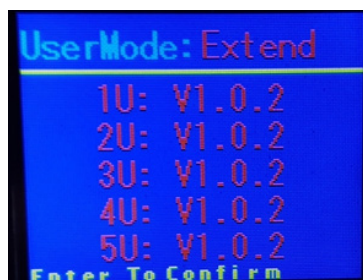

8. Aller dans le menu en pressant «Mode» > «Fonction» > «USB Update» > «OFF», sortir du menu.

WIRELESS SETTINGS :

W-DMX :

Sous-menu permettant l'activation ou la désactivation du DMX sans fil Wireless Solution

Rx / Tx :

Sous-menu permettant de sélectionner le mode du module Wireless Solution, soit en mode Receiver (Reception) ou Transmitter (Transmetteur).

Protocol :

Sous-menu permettant de sélectionner le mode de transmission du module Wireless Solution, soit en mode G3 (mode Legacy) ou en Mode G4S

Tx/Rx Link :

Sous-menu permettant d'appairer (Link) ou de des-appairer (Unlink) les projecteurs / récepteurs lorsque le Daytona est en mode Transmetteur

Receive Reset :

Sous-menu permettant de des-appairer le Daytona et de le placer en mode «attente d'appairage» lorsqu'il est en mode Receiver.

MENU INFORMATION

Time.Info

CurrentTime : Affichage du temps d'utilisation (en heures) depuis la dernière mise sous tension

TotalTime : Affichage du temps d'utilisation (en heure) depuis la première mise sous tension.

LastTime : Affichage du temps d'utilisation (en heure) depuis la dernière remise à zéro.

Time PIN : Pour accéder à la remise à zéro des temps d'utilisation il faut entrer un code PIN :

050 pour remettre à zéro le «Last Time»

060 pour remettre à zéro le «TotalTime»

ClearLast : ON/OFF pour remettre à zéro

ClearTOTAL : ON/OFF pour remettre à zéro

Temp.Info - Affichage de la température

xxx F ou C - Affichage de la température d

Fan Speed - Affichage de la vitesse du ventilateur

Fan : xxx RPM

Error.Info - Affichage des 10 derniers messages d'erreur.

Model.Info - Affichage du nom du modèle : Daytona

Software.V - Affichage de la version des différents processeurs

1U01 - Vx.x.x

2U01 - Vx.x.x

3U01 - Vx.x.x

4U01 - Vx.x.x

5U01 - Vx.x.x

6U01 - Vx.x.x

MENU TEST

Reset Motors

ALL : Reset de tous les moteurs

Pan&Tilt : Reset des moteurs Pan et Tilt

Head : Reset du Zoom

Test.Channel

Sous-menu permettant de tester tous les paramètres du Daytona tels que :

Pan, Pan Fine, Tilt, Tilt Fine, Red, Red Fine, Green, Green Fine, Blue, Blue Fine, White, White Fine, Strobe, Dimmer, Dim Fine, Zoom, DimMode, P/T Speed, Reset/Prog

Panel.Ctrl.

Sous-menu permettant de contrôler manuellement tous les paramètres du Daytona tels que :

Pan, Pan Fine, Tilt, Tilt Fine, Red, Red Fine, Green, Green Fine, Blue, Blue Fine, White, White Fine, Strobe, Dimmer, Dim Fine, Zoom, DimMode, P/T Speed, Reset/Prog

Calibrate :

Sous-menu permettant de recalibrer les moteurs et les Leds du Daytona pour accéder à ce menu il faut entrer le code PIN de déverrouillage de cette fonction.

Code Pin : 050

On accède ainsi aux différents paramètres :

Pan, Pan Fine, Tilt, Tilt Fine, Red, Red Fine, Green, Green Fine, Blue, Blue Fine, White, White Fine, Strobe, Dimmer, Dim Fine, Zoom.

AGENCEMENT DES PIXELS

VUE FACE AFFICHEUR, VALEUR PAN 128 - VALEUR TILT : 032

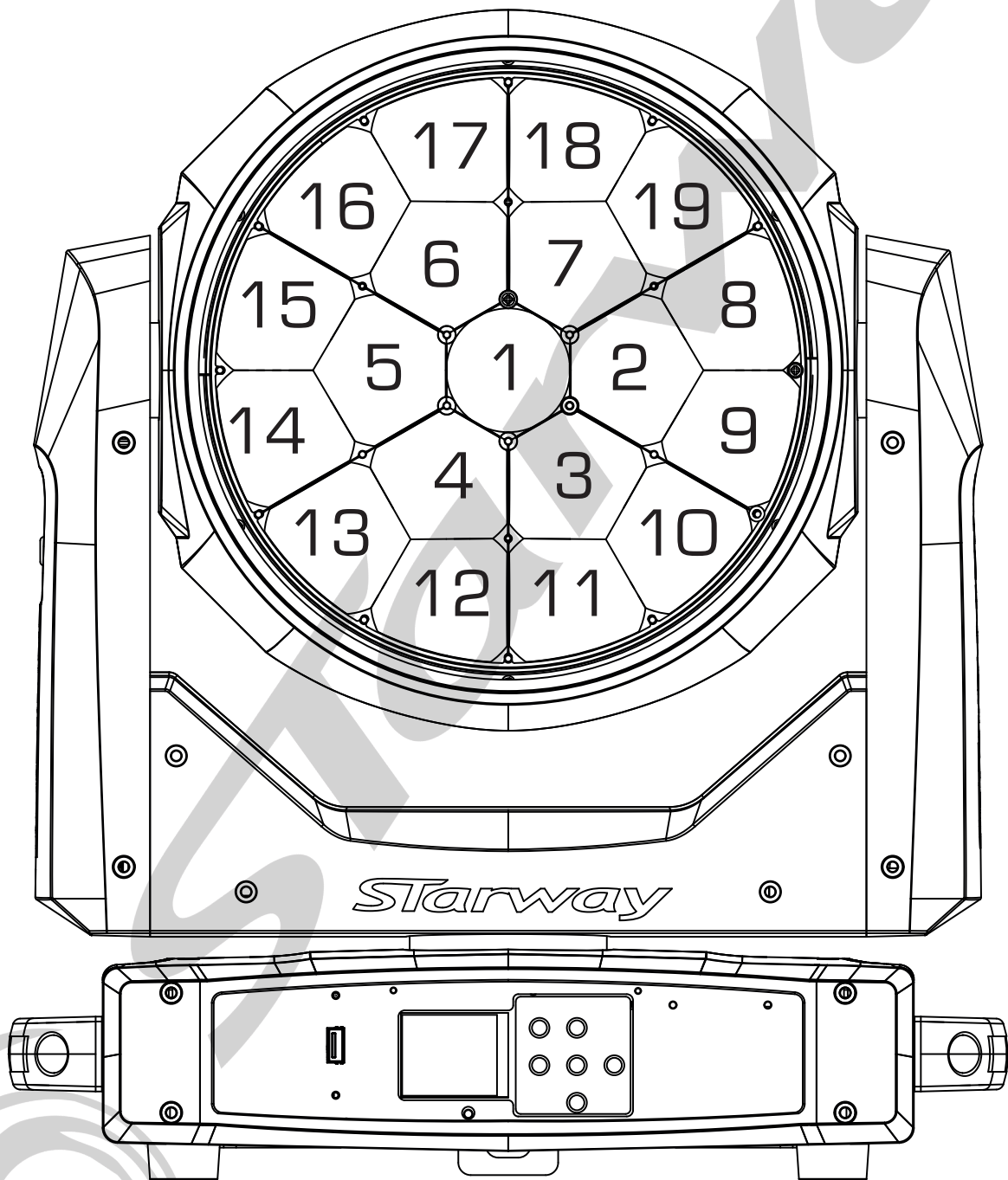

AFFECTATION DES CANAUX DMX

Mode BASIC 8B

Canal	Fonction	Valeur	Description	Informations
1	Pan	000 - 255	Pan	
2	Pan fine	000 - 255		
3	Tilt	000 - 255	Tilt	
4	Tilt fine	000 - 255		
5	Vitesse P/T	000 - 225	De Rapide à Lent	
		226 - 235	Mouvements au Black Out	
		236 - 255	Idle	
6	Dimmer	000 - 255	Dimmer	
7	Dimmer Fine	000 - 255	Dimmer Fine	
8	Strobe	000 - 009	Shutter fermé	
		010 - 019	Shutter ouvert	
		020 - 068	Strobe de lent à rapide	
		069 - 079	Shutter ouvert	
		080 - 128	Pulse en séquences	
		129 - 139	Shutter ouvert	
		140 - 188	Strobe random de lent à rapide	
		189 - 199	Shutter open	
		200 - 248	Strobe pixel random de lent à rapide	
249 - 255	Shutter ouvert			
9	Rouge	000 - 255	Rouge	
10	Vert	000 - 255	Vert	
11	Bleu	000 - 255	Bleu	
12	Blanc	000 - 255	Blanc	
13	Roue de Couleur Virtuelle	000 - 010	Macro de Blanc	Les canaux RGBW doivent avoir une valeur de 255 pour obtenir la bonne température de couleur. Il est possible d'ajuster la couleur avec RGBW
		011 - 012	Emulation Tungsten 3200°K	
		013 - 014	Emulation Tungsten 4000°K	
		015 - 016	Emulation Tungsten 4500°K	Seul le canal Blanc est actif et peut modifier la saturation des couleurs
		017 - 250	Roue de couleur virtuelle	
		251 - 253	Rotation de la roue couleur virtuelle sens horaire	
254 - 255	Rotation de la roue couleur virtuelle sens anti-horaire			
14	Fade / Vitesse Roue de Couleurs	000 - 255	Fade entre les couleurs virtuelles / Rotation de rapide à lent (de rapide à lent)	
15	Zoom	000 - 255	Zoom	de serré a large
16	Dim Modes	000 - 020	Selon le menu du projecteur	
		021 - 040	Standard	
		041 - 060	Stage	
		061 - 080	TV	
		081 - 100	Architectural	
		101 - 255	Theatre	

17	Contrôle	000 - 004	Idle	
		005 - 009	Inversion Pan on (Maintient 3s)	
		010 - 014	Inversion Pan off (Maintient 3s)	
		015 - 019	Inversion Tilt on (Maintient 3s)	
		020 - 024	Inversion Tilt off (Maintient 3s)	
		025 - 029	Fan Silent (Maintient 3s)	Le ventilateur tourne à vitesse lente constamment
		030 - 034	Fan Auto (Maintient 3s)	La vitesse du ventilateur est gérée automatiquement
		035 - 039	Fan High (Maintient 3s)	Le ventilateur tourne à vitesse haute constamment
		040 - 089	Idle	
		090 - 101	Courbe Linear (Maintient 3s)	
		102 - 113	Courbe Square (Maintient 3s)	
		114 - 125	Courbe Inv-Square (Maintient 3s)	
		126 - 131	Courbe S (Maintient 3s)	
		132 - 137	Led Freq. 900 Hz (Maintient 3s)	
		138 - 143	Led Freq. 1000 Hz (Maintient 3s)	
		144 - 149	Led Freq. 1100 Hz (Maintient 3s)	
		150 - 155	Led Freq. 1200 Hz (Maintient 3s)	
		156 - 161	Led Freq. 1300 Hz (Maintient 3s)	
		162 - 167	Led Freq. 1400 Hz (Maintient 3s)	
		168 - 173	Led Freq. 1500 Hz (Maintient 3s)	
		174 - 179	Led Freq. 2500 Hz (Maintient 3s)	
		180 - 185	Led Freq. 4000 Hz (Maintient 3s)	
		186 - 191	Led Freq. 5000 Hz (Maintient 3s)	
		192 - 197	Led Freq. 10000 Hz (Maintient 3s)	
		198 - 203	Led Freq. 15000 Hz (Maintient 3s)	
		204 - 209	Led Freq. 20000 Hz (Maintient 3s)	
		210 - 215	Led Freq. 25000 Hz (Maintient 3s)	
		216 - 218	Reset Pan/Tilt (Maintient 3s)	
		219 - 221	Reset du zoom (Maintient 3s)	
		222 - 224	Reset général (Maintient 3s)	
		225 - 234	Idle	
		235 - 237	Klingnet Désactivé	Les leds sont contrôlées uniquement par le dmx ou Artnet
		238 - 240	Leds controlled Klingnet only	Les leds sont contrôlées uniquement par le Klingnet
241 - 243	Leds controlled Klingnet + Dmx	Les leds sont contrôlées par le Klingnet mais le dmx est prioritaire sur RGBW		
244 - 246	Klingnet Calibration OFF	De manière à ce que le blanc Klingnet soit raccord avec par exemple un écran Led, il est possible de le calibrer dans le menu calibration du Daytona. Cette calibration peut être activée ou non depuis la console.		
247 - 249	Klingnet Calibration ON	De manière à ce que le blanc Klingnet soit raccord avec par exemple un écran Led, il est possible de le calibrer dans le menu calibration du Daytona. Cette calibration peut être activée ou non depuis la console.		
250 - 255	Idle			

Mode BASIC 16B

Canal	Fonction	Valeur	Description	Informations
1	Pan	000 - 255	Pan	
2	Pan fine	000 - 255		
3	Tilt	000 - 255	Tilt	
4	Tilt fine	000 - 255		
5	Vitesse P/T	000 - 225	De Rapide à Lent	
		226 - 235	Mouvements au Black Out	
		236 - 255	Idle	
6	Dimmer	000 - 255	Dimmer	
7	Dimmer Fine	000 - 255	Dimmer Fine	
8	Strobe	000 - 009	Shutter fermé	
		010 - 019	Shutter ouvert	
		020 - 068	Strobe de lent à rapide	
		069 - 079	Shutter ouvert	
		080 - 128	Pulse en séquences	
		129 - 139	Shutter ouvert	
		140 - 188	Strobe random de lent à rapide	
		189 - 199	Shutter open	
		200 - 248	Strobe pixel random de lent à rapide	
249 - 255	Shutter ouvert			
9	Rouge	000 - 255	Rouge	
10	Rouge Fine	000 - 255		
11	Vert	000 - 255	Vert	
12	Vert Fine	000 - 255		
13	Bleu	000 - 255	Bleu	
14	Bleu Fine	000 - 255		
15	Blanc	000 - 255	Blanc	
16	Blanc Fine	000 - 255		
17	Roue de Couleur Virtuelle	000 - 010	Macro de Blanc	Les canaux RGBW doivent avoir une valeur de 255 pour obtenir la bonne température de couleur. Est - il possible d'ajuster la couleur avec RGBW
		011 - 012	Emulation Tungsten 3200°K	
		013 - 014	Emulation Tungsten 4000°K	
		015 - 016	Emulation Tungsten 4500°K	Seul le canal Blanc est actif et peut modifier la saturation des couleurs
		017 - 250	Roue de couleur virtuelle	
		251 - 253	Rotation de la roue couleur virtuelle sens horaire	
254 - 255	Rotation de la roue couleur virtuelle sens anti - horaire			
18	Fade/Vitesse Roue de Couleurs	000 - 255	Fade entre les couleurs virtuelles / Rotation de rapide à lent (de rapide à lent)	
19	Zoom	000 - 255	Zoom	de serré a large
20	Dim Modes	000 - 020	Selon le menu du projecteur	
		021 - 040	Standard	
		041 - 060	Stage	
		061 - 080	TV	
		081 - 100	Architectural	
		101 - 255	Theatre	

21	Contrôle	000 - 004	Idle	
		005 - 009	Inversion Pan on (Maintient 3s)	
		010 - 014	Inversion Pan off (Maintient 3s)	
		015 - 019	Inversion Tilt on (Maintient 3s)	
		020 - 024	Inversion Tilt off (Maintient 3s)	
		025 - 029	Fan Silent (Maintient 3s)	Le ventilateur tourne à vitesse lente constamment
		030 - 034	Fan Auto (Maintient 3s)	La vitesse du ventilateur est gérée automatiquement
		035 - 039	Fan High (Maintient 3s)	Le ventilateur tourne à vitesse haute constamment
		040 - 089	Idle	
		090 - 101	Courbe Linear (Maintient 3s)	
		102 - 113	Courbe Square (Maintient 3s)	
		114 - 125	Courbe Inv - Square (Maintient 3s)	
		126 - 131	Courbe S (Maintient 3s)	
		132 - 137	Led Freq. 900 Hz (Maintient 3s)	
		138 - 143	Led Freq. 1000 Hz (Maintient 3s)	
		144 - 149	Led Freq. 1100 Hz (Maintient 3s)	
		150 - 155	Led Freq. 1200 Hz (Maintient 3s)	
		156 - 161	Led Freq. 1300 Hz (Maintient 3s)	
		162 - 167	Led Freq. 1400 Hz (Maintient 3s)	
		168 - 173	Led Freq. 1500 Hz (Maintient 3s)	
		174 - 179	Led Freq. 2500 Hz (Maintient 3s)	
		180 - 185	Led Freq. 4000 Hz (Maintient 3s)	
		186 - 191	Led Freq. 5000 Hz (Maintient 3s)	
		192 - 197	Led Freq. 10000 Hz (Maintient 3s)	
		198 - 203	Led Freq. 15000 Hz (Maintient 3s)	
		204 - 209	Led Freq. 20000 Hz (Maintient 3s)	
		210 - 215	Led Freq. 25000 Hz (Maintient 3s)	
		216 - 218	Reset Pan/Tilt (Maintient 3s)	
		219 - 221	Reset du zoom (Maintient 3s)	
		222 - 224	Reset général (Maintient 3s)	
		225 - 234	Idle	
		235 - 237	Klingnet Désactivé	Les leds sont contrôlées uniquement par le dmx ou Artnet
		238 - 240	Leds controled Klingnet only	Les leds sont contrôlées uniquement par le Klingnet
241 - 243	Leds controled Klingnet + Dmx	Les leds sont contrôlées par le Klingnet mais le dmx est prioritaire sur RGBW		
244 - 246	Klingnet Calibration OFF	De manière à ce que le blanc Klingnet soit raccord avec par exemple un écran Led, il est possible de le calibrer dans le menu calibration du Daytona. Cette calibration peut être activée ou non depuis la console.		
247 - 249	Klingnet Calibration ON	De manière à ce que le blanc Klingnet soit raccord avec par exemple un écran Led, il est possible de le calibrer dans le menu calibration du Daytona. Cette calibration peut être activée ou non depuis la console.		
250 - 255	Idle			

Mode Standard 8B

Canal	Fonction	Valeur	Description	Informations
1	Pan	000 - 255	Pan	
2	Pan fine	000 - 255		
3	Tilt	000 - 255	Tilt	
4	Tilt fine	000 - 255		
5	Vitesse P/T	000 - 225	De Rapide à Lent	
		226 - 235	Mouvements au Black Out	
		236 - 255	Idle	
6	Dimmer	000 - 255	Dimmer	
7	Dimmer Fine	000 - 255	Dimmer Fine	
8	Strobe	000 - 009	Shutter fermé	
		010 - 019	Shutter ouvert	
		020 - 068	Strobe de lent à rapide	
		069 - 079	Shutter ouvert	
		080 - 128	Pulse en séquences	
		129 - 139	Shutter ouvert	
		140 - 188	Strobe random de lent à rapide	
		189 - 199	Shutter open	
		200 - 248	Strobe pixel random de lent à rapide	
		249 - 255	Shutter ouvert	
9	Rouge	000 - 255	Rouge	
10	Vert	000 - 255	Vert	
11	Bleu	000 - 255	Bleu	
12	Blanc	000 - 255	Blanc	
13	Roue de Couleur Virtuelle Premier Plan	000 - 010	Macro de Blanc	Les canaux RGBW doivent avoir une valeur de 255 pour obtenir la bonne température de couleur. Est - il possible d'ajuster la couleur avec RGBW
		011 - 012	Emulation Tungsten 3200°K	
		013 - 014	Emulation Tungsten 4000°K	
		015 - 016	Emulation Tungsten 4500°K	
		017 - 250	Roue de couleur virtuelle	Seul le canal Blanc est actif et peut modifier la saturation des couleurs
		251 - 253	Rotation de la roue couleur virtuelle sens horaire	
254 - 255	Rotation de la roue couleur virtuelle sens anti - horaire			
14	Roue de Couleur Virtuelle Arrière Plan	000 - 010	Macro de Blanc	Les canaux RGBW doivent avoir une valeur de 255 pour obtenir la bonne température de couleur. Est - il possible d'ajuster la couleur avec RGBW
		011 - 016	Idle	
		017 - 250	Roue de couleur virtuelle	Seul le canal Blanc est actif et peut modifier la saturation des couleurs
		251 - 253	Rotation de la roue couleur virtuelle sens horaire	
		254 - 255	Rotation de la roue couleur virtuelle sens anti - horaire	
15	Fade / Vitesse Roue de Couleurs	000 - 255	Fade entre les couleurs virtuelles / Rotation de rapide à lent (de rapide à lent)	

16	Pattern	000 - 009	Pas de pattern
		010 - 017	Pattern # 1
		018 - 025	Pattern # 2
		026 - 033	Pattern # 3
		034 - 041	Pattern # 4
		042 - 049	Pattern # 5
		050 - 057	Pattern # 6
		058 - 065	Pattern # 7
		066 - 073	Pattern # 8
		074 - 081	Pattern # 9
		082 - 089	Pattern # 10
		090 - 097	Pattern # 11
		098 - 105	Pattern # 12
		106 - 113	Pattern # 13
		114 - 121	Pattern # 14
		122 - 129	Pattern # 15
		130 - 137	Pattern # 16
		138 - 145	Pattern # 17
		146 - 153	Pattern # 18
		154 - 161	Pattern # 19
		162 - 169	Pattern # 20
		170 - 177	Pattern # 21
		178 - 185	Pattern # 22
		186 - 193	Pattern # 23
		194 - 201	Pattern # 24
		202 - 209	Pattern # 25
		210 - 217	Pattern # 26
		218 - 225	Pattern # 27
		226 - 233	Pattern # 28
		234 - 241	Pattern # 29
		242 - 249	Pattern # 30
250 - 255	Idle		

17	Pas des Patterns	000	Pas Statique # 1	Sélection de l'un des 30 pas possibles de la pattern sélectionnée. Si le numéro de pas est vide, les LEDs sont éteintes
		001	Pas Statique # 2	
		002	Pas Statique # 3	
		003	Pas Statique # 4	
		004	Pas Statique # 5	
		005	Pas Statique # 6	
		006	Pas Statique # 7	
		007	Pas Statique # 8	
		008	Pas Statique # 9	
		009	Pas Statique # 10	
		010	Pas Statique # 11	
		011	Pas Statique # 12	
		012	Pas Statique # 13	
		013	Pas Statique # 14	
		014	Pas Statique # 15	
		015	Pas Statique # 16	
		016	Pas Statique # 17	
		017	Pas Statique # 18	
		018	Pas Statique # 19	
		019	Pas Statique # 20	
		020	Pas Statique # 21	
		021	Pas Statique # 22	
		022	Pas Statique # 23	
		023	Pas Statique # 24	
		024	Pas Statique # 25	
		025	Pas Statique # 26	
		026	Pas Statique # 27	
		027	Pas Statique # 28	
		028	Pas Statique # 29	
		029	Pas Statique # 30	
030 - 039	Idle			
040 - 145	Défilement des patterns vers l'avant (de rapide à lent)			
146 - 149	Stop			
150 - 255	Défilement des patterns vers l'arrière (de lent à rapide)			
18	Fade entre les pas des patterns	000	Pas de fade entre les pas	
		001 - 255	Fade de rapide à lent	
19	Zoom	000 - 255	Zoom	de serré a large
20	Dim Modes	000 - 020	Selon le menu du projecteur	
		021 - 040	Standard	
		041 - 060	Stage	
		061 - 080	TV	
		081 - 100	Architectural	
		101 - 255	Theatre	

21	Contrôle	000 - 004	Idle	
		005 - 009	Inversion Pan on (Maintient 3s)	
		010 - 014	Inversion Pan off (Maintient 3s)	
		015 - 019	Inversion Tilt on (Maintient 3s)	
		020 - 024	Inversion Tilt off (Maintient 3s)	
		025 - 029	Fan Silent (Maintient 3s)	Le ventilateur tourne à vitesse lente constamment
		030 - 034	Fan Auto (Maintient 3s)	La vitesse du ventilateur est gérée automatiquement
		035 - 039	Fan High (Maintient 3s)	Le ventilateur tourne à vitesse haute constamment
		040 - 089	Idle	
		090 - 101	Courbe Linear (Maintient 3s)	
		102 - 113	Courbe Square (Maintient 3s)	
		114 - 125	Courbe Inv - Square (Maintient 3s)	
		126 - 131	Courbe S (Maintient 3s)	
		132 - 137	Led Freq. 900 Hz (Maintient 3s)	
		138 - 143	Led Freq. 1000 Hz (Maintient 3s)	
		144 - 149	Led Freq. 1100 Hz (Maintient 3s)	
		150 - 155	Led Freq. 1200 Hz (Maintient 3s)	
		156 - 161	Led Freq. 1300 Hz (Maintient 3s)	
		162 - 167	Led Freq. 1400 Hz (Maintient 3s)	
		168 - 173	Led Freq. 1500 Hz (Maintient 3s)	
		174 - 179	Led Freq. 2500 Hz (Maintient 3s)	
		180 - 185	Led Freq. 4000 Hz (Maintient 3s)	
		186 - 191	Led Freq. 5000 Hz (Maintient 3s)	
		192 - 197	Led Freq. 10000 Hz (Maintient 3s)	
		198 - 203	Led Freq. 15000 Hz (Maintient 3s)	
		204 - 209	Led Freq. 20000 Hz (Maintient 3s)	
		210 - 215	Led Freq. 25000 Hz (Maintient 3s)	
		216 - 218	Reset Pan/Tilt (Maintient 3s)	
		219 - 221	Reset du zoom (Maintient 3s)	
		222 - 224	Reset général (Maintient 3s)	
		225 - 234	Idle	
		235 - 237	Klingnet Désactivé	Les leds sont contrôlées uniquement par le dmx ou Artnet
238 - 240	Leds controlled Klingnet only	Les leds sont contrôlées uniquement par le Klingnet		
241 - 243	Leds controlled Klingnet + Dmx	Les leds sont contrôlées par le Klingnet mais le dmx est prioritaire sur RGBW		
244 - 246	Klingnet Calibration OFF	De manière à ce que le blanc Klingnet soit raccord avec par exemple un écran Led, il est possible de le calibrer dans le menu calibration du Daytona. Cette calibration peut être activée ou non depuis la console.		
247 - 249	Klingnet Calibration ON	De manière à ce que le blanc Klingnet soit raccord avec par exemple un écran Led, il est possible de le calibrer dans le menu calibration du Daytona. Cette calibration peut être activée ou non depuis la console.		
250 - 255	Idle			

Mode Standard 16B

Canal	Fonction	Valeur	Description	Informations
1	Pan	000 - 255	Pan	
2	Pan fine	000 - 255		
3	Tilt	000 - 255	Tilt	
4	Tilt fine	000 - 255		
5	Vitesse P/T	000 - 225	De Rapide à Lent	
		226 - 235	Mouvements au Black Out	
		236 - 255	Idle	
6	Dimmer	000 - 255	Dimmer	
7	Dimmer Fine	000 - 255	Dimmer Fine	
8	Strobe	000 - 009	Shutter fermé	
		010 - 019	Shutter ouvert	
		020 - 068	Strobe de lent à rapide	
		069 - 079	Shutter ouvert	
		080 - 128	Pulse en séquences	
		129 - 139	Shutter ouvert	
		140 - 188	Strobe random de lent à rapide	
		189 - 199	Shutter open	
		200 - 248	Strobe pixel random de lent à rapide	
		249 - 255	Shutter ouvert	
9	Rouge	000 - 255	Rouge	
10	Rouge Fine	000 - 255		
11	Vert	000 - 255	Vert	
12	Vert Fine	000 - 255		
13	Bleu	000 - 255	Bleu	
14	Bleu Fine	000 - 255		
15	Blanc	000 - 255	Blanc	
16	Blanc Fine	000 - 255		
17	Roue de Couleur Virtuelle Premier Plan	000 - 010	Macro de Blanc	Les canaux RGBW doivent avoir une valeur de 255 pour obtenir la bonne température de couleur. Est - il possible d'ajuster la couleur avec RGBW
		011 - 012	Emulation Tungsten 3200°K	
		013 - 014	Emulation Tungsten 4000°K	
		015 - 016	Emulation Tungsten 4500°K	Seul le canal Blanc est actif et peut modifier la saturation des couleurs
		017 - 250	Roue de couleur virtuelle	
		251 - 253	Rotation de la roue couleur virtuelle sens horaire	
254 - 255	Rotation de la roue couleur virtuelle sens anti - horaire			
18	Roue de Couleur Virtuelle Arrière Plan	000 - 010	Macro de Blanc	Les canaux RGBW doivent avoir une valeur de 255 pour obtenir la bonne température de couleur. Est - il possible d'ajuster la couleur avec RGBW
		011 - 016	Idle	
		017 - 250	Roue de couleur virtuelle	Seul le canal Blanc est actif et peut modifier la saturation des couleurs
		251 - 253	Rotation de la roue couleur virtuelle sens horaire	
		254 - 255	Rotation de la roue couleur virtuelle sens anti - horaire	
		19	Fade / Vitesse Roue de Couleurs	000 - 255

20	Pattern	000 - 009	Pas de pattern
		010 - 017	Pattern # 1
		018 - 025	Pattern # 2
		026 - 033	Pattern # 3
		034 - 041	Pattern # 4
		042 - 049	Pattern # 5
		050 - 057	Pattern # 6
		058 - 065	Pattern # 7
		066 - 073	Pattern # 8
		074 - 081	Pattern # 9
		082 - 089	Pattern # 10
		090 - 097	Pattern # 11
		098 - 105	Pattern # 12
		106 - 113	Pattern # 13
		114 - 121	Pattern # 14
		122 - 129	Pattern # 15
		130 - 137	Pattern # 16
		138 - 145	Pattern # 17
		146 - 153	Pattern # 18
		154 - 161	Pattern # 19
		162 - 169	Pattern # 20
		170 - 177	Pattern # 21
		178 - 185	Pattern # 22
		186 - 193	Pattern # 23
		194 - 201	Pattern # 24
		202 - 209	Pattern # 25
		210 - 217	Pattern # 26
		218 - 225	Pattern # 27
		226 - 233	Pattern # 28
		234 - 241	Pattern # 29
		242 - 249	Pattern # 30
	250 - 255	Idle	

21	Pas des Patterns	000	Pas Statique # 1	Sélection de l'un des 30 pas possibles de la pattern sélectionnée. Si le numéro de pas est vide, les LEDs sont éteintes
		001	Pas Statique # 2	
		002	Pas Statique # 3	
		003	Pas Statique # 4	
		004	Pas Statique # 5	
		005	Pas Statique # 6	
		006	Pas Statique # 7	
		007	Pas Statique # 8	
		008	Pas Statique # 9	
		009	Pas Statique # 10	
		010	Pas Statique # 11	
		011	Pas Statique # 12	
		012	Pas Statique # 13	
		013	Pas Statique # 14	
		014	Pas Statique # 15	
		015	Pas Statique # 16	
		016	Pas Statique # 17	
		017	Pas Statique # 18	
		018	Pas Statique # 19	
		019	Pas Statique # 20	
		020	Pas Statique # 21	
		021	Pas Statique # 22	
		022	Pas Statique # 23	
		023	Pas Statique # 24	
		024	Pas Statique # 25	
		025	Pas Statique # 26	
		026	Pas Statique # 27	
		027	Pas Statique # 28	
		028	Pas Statique # 29	
		029	Pas Statique # 30	
		030 - 039	Idle	
		040 - 145	Défilement des patterns vers l'avant (de rapide à lent)	
		146 - 149	Stop	
		150 - 255	Défilement des patterns vers l'arrière (de lent à rapide)	
22	Fade entre les pas des patterns	000	Pas de fade entre les pas	
		001 - 255	Fade de rapide à lent	
23	Zoom	000 - 255	Zoom	de serré a large
24	Dim Modes	000 - 020	Selon le menu du projecteur	
		021 - 040	Standard	
		041 - 060	Stage	
		061 - 080	TV	
		081 - 100	Architectural	
		101 - 255	Theatre	

25	Contrôle	000 - 004	Idle	
		005 - 009	Inversion Pan on (Maintient 3s)	
		010 - 014	Inversion Pan off (Maintient 3s)	
		015 - 019	Inversion Tilt on (Maintient 3s)	
		020 - 024	Inversion Tilt off (Maintient 3s)	
		025 - 029	Fan Silent (Maintient 3s)	Le ventilateur tourne à vitesse lente constamment
		030 - 034	Fan Auto (Maintient 3s)	La vitesse du ventilateur est gérée automatiquement
		035 - 039	Fan High (Maintient 3s)	Le ventilateur tourne à vitesse haute constamment
		040 - 089	Idle	
		090 - 101	Courbe Linear (Maintient 3s)	
		102 - 113	Courbe Square (Maintient 3s)	
		114 - 125	Courbe Inv - Square (Maintient 3s)	
		126 - 131	Courbe S (Maintient 3s)	
		132 - 137	Led Freq. 900 Hz (Maintient 3s)	
		138 - 143	Led Freq. 1000 Hz (Maintient 3s)	
		144 - 149	Led Freq. 1100 Hz (Maintient 3s)	
		150 - 155	Led Freq. 1200 Hz (Maintient 3s)	
		156 - 161	Led Freq. 1300 Hz (Maintient 3s)	
		162 - 167	Led Freq. 1400 Hz (Maintient 3s)	
		168 - 173	Led Freq. 1500 Hz (Maintient 3s)	
		174 - 179	Led Freq. 2500 Hz (Maintient 3s)	
		180 - 185	Led Freq. 4000 Hz (Maintient 3s)	
		186 - 191	Led Freq. 5000 Hz (Maintient 3s)	
		192 - 197	Led Freq. 10000 Hz (Maintient 3s)	
		198 - 203	Led Freq. 15000 Hz (Maintient 3s)	
		204 - 209	Led Freq. 20000 Hz (Maintient 3s)	
		210 - 215	Led Freq. 25000 Hz (Maintient 3s)	
		216 - 218	Reset Pan/Tilt (Maintient 3s)	
		219 - 221	Reset du zoom (Maintient 3s)	
		222 - 224	Reset général (Maintient 3s)	
		225 - 234	Idle	
		235 - 237	Klingnet Désactivé	Les leds sont contrôlés uniquement par le dmx ou Artnet
238 - 240	Leds controlled Klingnet only	Les leds sont contrôlés uniquement par le Klingnet		
241 - 243	Leds controlled Klingnet + Dmx	Les leds sont contrôlés par le Klingnet mais le dmx est prioritaire sur RGBW		
244 - 246	Klingnet Calibration OFF	De manière à ce que le blanc Klingnet soit raccordé avec par exemple un écran Led, il est possible de le calibrer dans le menu calibration du Daytona. Cette calibration peut être activée ou non depuis la console.		
247 - 249	Klingnet Calibration ON	De manière à ce que le blanc Klingnet soit raccordé avec par exemple un écran Led, il est possible de le calibrer dans le menu calibration du Daytona. Cette calibration peut être activée ou non depuis la console.		
250 - 255	Idle			

Mode Pixel 8B

Canal	Fonction	Valeur	Description	Informations
1	Pan	000 - 255	Pan	
2	Pan fine	000 - 255		
3	Tilt	000 - 255	Tilt	
4	Tilt fine	000 - 255		
5	Vitesse P/T	000 - 225	De Rapide à Lent	
		226 - 235	Mouvements au Black Out	
		236 - 255	Idle	
6	Dimmer	000 - 255	Dimmer	
7	Dimmer Fine	000 - 255	Dimmer Fine	
8	Strobe	000 - 009	Shutter fermé	
		010 - 019	Shutter ouvert	
		020 - 068	Strobe de lent à rapide	
		069 - 079	Shutter ouvert	
		080 - 128	Pulse en séquences	
		129 - 139	Shutter ouvert	
		140 - 188	Strobe random de lent à rapide	
		189 - 199	Shutter open	
		200 - 248	Strobe pixel random de lent à rapide	
249 - 255	Shutter ouvert			
9	Rouge	000 - 255	Rouge (Toutes les Leds)	
10	Vert	000 - 255	Vert (Toutes les Leds)	
11	Bleu	000 - 255	Bleu (Toutes les Leds)	
12	Blanc	000 - 255	Blanc (Toutes les Leds)	
13	Roue de Couleur Virtuelle	000 - 010	Macro de Blanc	Les canaux RGBW doivent avoir une valeur de 255 pour obtenir la bonne température de couleur. Est - il possible d'ajuster la couleur avec RGBW
		011 - 012	Emulation Tungsten 3200°K	
		013 - 014	Emulation Tungsten 4000°K	
		015 - 016	Emulation Tungsten 4500°K	
		017 - 250	Roue de couleur virtuelle	Seul le canal Blanc est actif et peut modifier la saturation des couleurs
251 - 253	Rotation de la roue couleur virtuelle sens horaire			
254 - 255	Rotation de la roue couleur virtuelle sens anti - horaire			
14	Fade / Vitesse Roue de Couleurs	000 - 255	Fade entre les couleurs virtuelles / Rotation de rapide à lent (de rapide à lent)	
15	Zoom	000 - 255	Zoom	de serré a large
16	Dim Modes	000 - 020	Selon le menu du projecteur	
		021 - 040	Standard	
		041 - 060	Stage	
		061 - 080	TV	
		081 - 100	Architectural	
		101 - 255	Theatre	

17	Contrôle	000 - 004	Idle	
		005 - 009	Inversion Pan on (Maintient 3s)	
		010 - 014	Inversion Pan off (Maintient 3s)	
		015 - 019	Inversion Tilt on (Maintient 3s)	
		020 - 024	Inversion Tilt off (Maintient 3s)	
		025 - 029	Fan Silent (Maintient 3s)	Le ventilateur tourne à vitesse lente constamment
		030 - 034	Fan Auto (Maintient 3s)	La vitesse du ventilateur est gérée automatiquement
		035 - 039	Fan High (Maintient 3s)	Le ventilateur tourne à vitesse haute constamment
		040 - 089	Idle	
		090 - 101	Courbe Linear (Maintient 3s)	
		102 - 113	Courbe Square (Maintient 3s)	
		114 - 125	Courbe Inv - Square (Maintient 3s)	
		126 - 131	Courbe S (Maintient 3s)	
		132 - 137	Led Freq. 900 Hz (Maintient 3s)	
		138 - 143	Led Freq. 1000 Hz (Maintient 3s)	
		144 - 149	Led Freq. 1100 Hz (Maintient 3s)	
		150 - 155	Led Freq. 1200 Hz (Maintient 3s)	
		156 - 161	Led Freq. 1300 Hz (Maintient 3s)	
		162 - 167	Led Freq. 1400 Hz (Maintient 3s)	
		168 - 173	Led Freq. 1500 Hz (Maintient 3s)	
		174 - 179	Led Freq. 2500 Hz (Maintient 3s)	
		180 - 185	Led Freq. 4000 Hz (Maintient 3s)	
		186 - 191	Led Freq. 5000 Hz (Maintient 3s)	
		192 - 197	Led Freq. 10000 Hz (Maintient 3s)	
		198 - 203	Led Freq. 15000 Hz (Maintient 3s)	
		204 - 209	Led Freq. 20000 Hz (Maintient 3s)	
		210 - 215	Led Freq. 25000 Hz (Maintient 3s)	
		216 - 218	Reset Pan/Tilt (Maintient 3s)	
		219 - 221	Reset du zoom (Maintient 3s)	
		222 - 224	Reset général (Maintient 3s)	
		225 - 234	Idle	
		235 - 237	Klingnet Désactivé	Les leds sont contrôlées uniquement par le dmx ou Artnet
		238 - 240	Leds contrôlées Klingnet only	Les leds sont contrôlées uniquement par le Klingnet
241 - 243	Leds contrôlées Klingnet + Dmx	Les leds sont contrôlées par le Klingnet mais le dmx est prioritaire sur RGBW		
244 - 246	Klingnet Calibration OFF	De manière à ce que le blanc Klingnet soit raccordé avec par exemple un écran Led, il est possible de le calibrer dans le menu calibration du Daytona. Cette calibration peut être activée ou non depuis la console.		
247 - 249	Klingnet Calibration ON	De manière à ce que le blanc Klingnet soit raccordé avec par exemple un écran Led, il est possible de le calibrer dans le menu calibration du Daytona. Cette calibration peut être activée ou non depuis la console.		
250 - 255	Idle			

18	Rouge	000 - 255	Pixel #1
19	Vert	000 - 255	
20	Bleu	000 - 255	
21	Blanc	000 - 255	
22	Rouge	000 - 255	Pixel #2
23	Vert	000 - 255	
24	Bleu	000 - 255	
25	Blanc	000 - 255	Pixel #3
26	Rouge	000 - 255	
27	Vert	000 - 255	
28	Bleu	000 - 255	
29	Blanc	000 - 255	Pixel #4
30	Rouge	000 - 255	
31	Vert	000 - 255	
32	Bleu	000 - 255	
33	Blanc	000 - 255	Pixel #5
34	Rouge	000 - 255	
35	Vert	000 - 255	
36	Bleu	000 - 255	Pixel #6
37	Blanc	000 - 255	
38	Rouge	000 - 255	
39	Vert	000 - 255	
40	Bleu	000 - 255	Pixel #7
41	Blanc	000 - 255	
42	Rouge	000 - 255	
43	Vert	000 - 255	Pixel #8
44	Bleu	000 - 255	
45	Blanc	000 - 255	
46	Rouge	000 - 255	
47	Vert	000 - 255	Pixel #9
48	Bleu	000 - 255	
49	Blanc	000 - 255	
50	Rouge	000 - 255	Pixel #10
51	Vert	000 - 255	
52	Bleu	000 - 255	
53	Blanc	000 - 255	
54	Rouge	000 - 255	Pixel #11
55	Vert	000 - 255	
56	Bleu	000 - 255	
57	Blanc	000 - 255	Pixel #12
58	Rouge	000 - 255	
59	Vert	000 - 255	
60	Bleu	000 - 255	
61	Blanc	000 - 255	Pixel #12
62	Rouge	000 - 255	
63	Vert	000 - 255	
64	Bleu	000 - 255	
65	Blanc	000 - 255	

66	Rouge	000 - 255	Pixel #13
67	Vert	000 - 255	
68	Bleu	000 - 255	
69	Blanc	000 - 255	
70	Rouge	000 - 255	Pixel #14
71	Vert	000 - 255	
72	Bleu	000 - 255	
73	Blanc	000 - 255	
74	Rouge	000 - 255	Pixel #15
75	Vert	000 - 255	
76	Bleu	000 - 255	
77	Blanc	000 - 255	
78	Rouge	000 - 255	Pixel #16
79	Vert	000 - 255	
80	Bleu	000 - 255	
81	Blanc	000 - 255	
82	Rouge	000 - 255	Pixel #17
83	Vert	000 - 255	
84	Bleu	000 - 255	
85	Blanc	000 - 255	
86	Rouge	000 - 255	Pixel #18
87	Vert	000 - 255	
88	Bleu	000 - 255	
89	Blanc	000 - 255	
90	Rouge	000 - 255	Pixel #19
91	Vert	000 - 255	
92	Bleu	000 - 255	
93	Blanc	000 - 255	

Mode Pixel 16B

Canal	Fonction	Valeur	Description	Informations
1	Pan	000 - 255	Pan	
2	Pan fine	000 - 255		
3	Tilt	000 - 255	Tilt	
4	Tilt fine	000 - 255		
5	Vitesse P/T	000 - 225	De Rapide à Lent	
		226 - 235	Mouvements au Black Out	
		236 - 255	Idle	
6	Dimmer	000 - 255	Dimmer	
7	Dimmer Fine	000 - 255	Dimmer Fine	
8	Strobe	000 - 009	Shutter fermé	
		010 - 019	Shutter ouvert	
		020 - 068	Strobe de lent à rapide	
		069 - 079	Shutter ouvert	
		080 - 128	Pulse en séquences	
		129 - 139	Shutter ouvert	
		140 - 188	Strobe random de lent à rapide	
		189 - 199	Shutter open	
		200 - 248	Strobe pixel random de lent à rapide	
249 - 255	Shutter ouvert			
9	Zoom	000 - 255	Zoom	de serré a large
10	Dim Modes	000 - 020	Selon le menu du projecteur	
		021 - 040	Standard	
		041 - 060	Stage	
		061 - 080	TV	
		081 - 100	Architectural	
		101 - 255	Theatre	
11	Contrôle	000 - 004	Idle	
		005 - 009	Inversion Pan on (Maintient 3s)	
		010 - 014	Inversion Pan off (Maintient 3s)	
		015 - 019	Inversion Tilt on (Maintient 3s)	
		020 - 024	Inversion Tilt off (Maintient 3s)	
		025 - 029	Fan Silent (Maintient 3s)	Le ventilateur tourne à vitesse lente constamment
		030 - 034	Fan Auto (Maintient 3s)	La vitesse du ventilateur est gérée automatiquement
		035 - 039	Fan High (Maintient 3s)	Le ventilateur tourne à vitesse haute constamment
		040 - 089	Idle	
		090 - 101	Courbe Linear (Maintient 3s)	
		102 - 113	Courbe Square (Maintient 3s)	
		114 - 125	Courbe Inv - Square (Maintient 3s)	
		126 - 131	Courbe S (Maintient 3s)	
		132 - 137	Led Freq. 900 Hz (Maintient 3s)	
		138 - 143	Led Freq. 1000 Hz (Maintient 3s)	
		144 - 149	Led Freq. 1100 Hz (Maintient 3s)	
		150 - 155	Led Freq. 1200 Hz (Maintient 3s)	
		156 - 161	Led Freq. 1300 Hz (Maintient 3s)	
		162 - 167	Led Freq. 1400 Hz (Maintient 3s)	
		168 - 173	Led Freq. 1500 Hz (Maintient 3s)	
		174 - 179	Led Freq. 2500 Hz (Maintient 3s)	
		180 - 185	Led Freq. 4000 Hz (Maintient 3s)	
		186 - 191	Led Freq. 5000 Hz (Maintient 3s)	
		192 - 197	Led Freq. 10000 Hz (Maintient 3s)	
198 - 203	Led Freq. 15000 Hz (Maintient 3s)			
204 - 209	Led Freq. 20000 Hz (Maintient 3s)			
210 - 215	Led Freq. 25000 Hz (Maintient 3s)			

11	Contrôle	216 - 218	Reset Pan/Tilt (Maintient 3s)	
		219 - 221	Reset du zoom (Maintient 3s)	
		222 - 224	Reset général (Maintient 3s)	
		225 - 234	Idle	
		235 - 237	Klingnet Désactivé	Les leds sont controlées uniquement par le dmx ou Artnet
		238 - 240	Leds controled Klingnet only	Les leds sont controlées uniquement par le Klingnet
		241 - 243	Leds controled Klingnet + Dmx	Les leds sont controlées par le Klingnet mais le dmx est prioritaire sur RGBW
		244 - 246	Klingnet Calibration OFF	De manière à ce que le blanc Klingnet soit raccord avec par exemple un ecran Led, il est possible de le calibrer dans le menu calibration du Daytona. Cette calibration peut etre activée ou non depuis la console.
		247 - 249	Klingnet Calibration ON	De manière à ce que le blanc Klingnet soit raccord avec par exemple un ecran Led, il est possible de le calibrer dans le menu calibration du Daytona. Cette calibration peut etre activée ou non depuis la console.
		250 - 255	Idle	
12	Rouge	000 - 255	Pixel #1	
13	Rouge Fine	000 - 255		
14	Vert	000 - 255		
15	Vert Fine	000 - 255		
16	Bleu	000 - 255		
17	Bleu Fine	000 - 255		
18	Blanc	000 - 255		
19	Blanc Fine	000 - 255		
20	Rouge	000 - 255	Pixel #2	
21	Rouge Fine	000 - 255		
22	Vert	000 - 255		
23	Vert Fine	000 - 255		
24	Bleu	000 - 255		
25	Bleu Fine	000 - 255		
26	Blanc	000 - 255		
27	Blanc Fine	000 - 255		
28	Rouge	000 - 255	Pixel #3	
29	Rouge Fine	000 - 255		
30	Vert	000 - 255		
31	Vert Fine	000 - 255		
32	Bleu	000 - 255		
33	Bleu Fine	000 - 255		
34	Blanc	000 - 255		
35	Blanc Fine	000 - 255		
36	Rouge	000 - 255	Pixel #4	
37	Rouge Fine	000 - 255		
38	Vert	000 - 255		
39	Vert Fine	000 - 255		
40	Bleu	000 - 255		
41	Bleu Fine	000 - 255		
42	Blanc	000 - 255		
43	Blanc Fine	000 - 255		
44	Rouge	000 - 255	Pixel #5	
45	Rouge Fine	000 - 255		
46	Vert	000 - 255		
47	Vert Fine	000 - 255		
48	Bleu	000 - 255		
49	Bleu Fine	000 - 255		
50	Blanc	000 - 255		
51	Blanc Fine	000 - 255		

52	Rouge	000 - 255	Pixel #6
53	Rouge Fine	000 - 255	
54	Vert	000 - 255	
55	Vert Fine	000 - 255	
56	Bleu	000 - 255	
57	Bleu Fine	000 - 255	
58	Blanc	000 - 255	
59	Blanc Fine	000 - 255	
60	Rouge	000 - 255	Pixel #7
61	Rouge Fine	000 - 255	
62	Vert	000 - 255	
63	Vert Fine	000 - 255	
64	Bleu	000 - 255	
65	Bleu Fine	000 - 255	
66	Blanc	000 - 255	
67	Blanc Fine	000 - 255	
68	Rouge	000 - 255	Pixel #8
69	Rouge Fine	000 - 255	
70	Vert	000 - 255	
71	Vert Fine	000 - 255	
72	Bleu	000 - 255	
73	Bleu Fine	000 - 255	
74	Blanc	000 - 255	
75	Blanc Fine	000 - 255	
76	Rouge	000 - 255	Pixel #9
77	Rouge Fine	000 - 255	
78	Vert	000 - 255	
79	Vert Fine	000 - 255	
80	Bleu	000 - 255	
81	Bleu Fine	000 - 255	
82	Blanc	000 - 255	
83	Blanc Fine	000 - 255	
84	Rouge	000 - 255	Pixel #10
85	Rouge Fine	000 - 255	
86	Vert	000 - 255	
87	Vert Fine	000 - 255	
88	Bleu	000 - 255	
89	Bleu Fine	000 - 255	
90	Blanc	000 - 255	
91	Blanc Fine	000 - 255	
92	Rouge	000 - 255	Pixel #11
93	Rouge Fine	000 - 255	
94	Vert	000 - 255	
95	Vert Fine	000 - 255	
96	Bleu	000 - 255	
97	Bleu Fine	000 - 255	
98	Blanc	000 - 255	
99	Blanc Fine	000 - 255	
100	Rouge	000 - 255	Pixel #12
101	Rouge Fine	000 - 255	
102	Vert	000 - 255	
103	Vert Fine	000 - 255	
104	Bleu	000 - 255	
105	Bleu Fine	000 - 255	
106	Blanc	000 - 255	
107	Blanc Fine	000 - 255	

108	Rouge	000 - 255	Pixel #13
109	Rouge Fine	000 - 255	
110	Vert	000 - 255	
111	Vert Fine	000 - 255	
112	Bleu	000 - 255	
113	Bleu Fine	000 - 255	
114	Blanc	000 - 255	
115	Blanc Fine	000 - 255	
116	Rouge	000 - 255	Pixel #14
117	Rouge Fine	000 - 255	
118	Vert	000 - 255	
119	Vert Fine	000 - 255	
120	Bleu	000 - 255	
121	Bleu Fine	000 - 255	
122	Blanc	000 - 255	
123	Blanc Fine	000 - 255	
124	Rouge	000 - 255	Pixel #15
125	Rouge Fine	000 - 255	
126	Vert	000 - 255	
127	Vert Fine	000 - 255	
128	Bleu	000 - 255	
129	Bleu Fine	000 - 255	
130	Blanc	000 - 255	
131	Blanc Fine	000 - 255	
132	Rouge	000 - 255	Pixel #16
133	Rouge Fine	000 - 255	
134	Vert	000 - 255	
135	Vert Fine	000 - 255	
136	Bleu	000 - 255	
137	Bleu Fine	000 - 255	
138	Blanc	000 - 255	
139	Blanc Fine	000 - 255	
140	Rouge	000 - 255	Pixel #17
141	Rouge Fine	000 - 255	
142	Vert	000 - 255	
143	Vert Fine	000 - 255	
144	Bleu	000 - 255	
145	Bleu Fine	000 - 255	
146	Blanc	000 - 255	
147	Blanc Fine	000 - 255	
148	Rouge	000 - 255	Pixel #18
149	Rouge Fine	000 - 255	
150	Vert	000 - 255	
151	Vert Fine	000 - 255	
152	Bleu	000 - 255	
153	Bleu Fine	000 - 255	
154	Blanc	000 - 255	
155	Blanc Fine	000 - 255	
156	Rouge	000 - 255	Pixel #19
157	Rouge Fine	000 - 255	
158	Vert	000 - 255	
159	Vert Fine	000 - 255	
160	Bleu	000 - 255	
161	Bleu Fine	000 - 255	
162	Blanc	000 - 255	
163	Blanc Fine	000 - 255	

Pattern #1

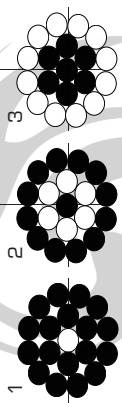

Pattern #2

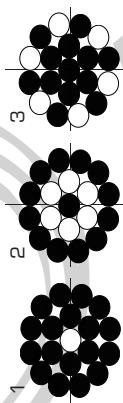

Pattern #3

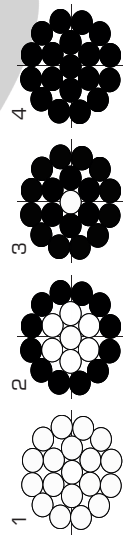

Pattern #4

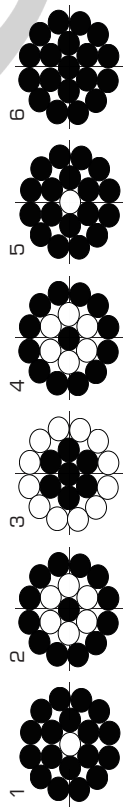

Pattern #5

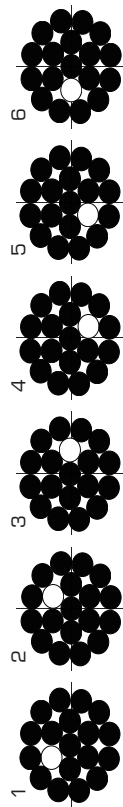

Pattern #6

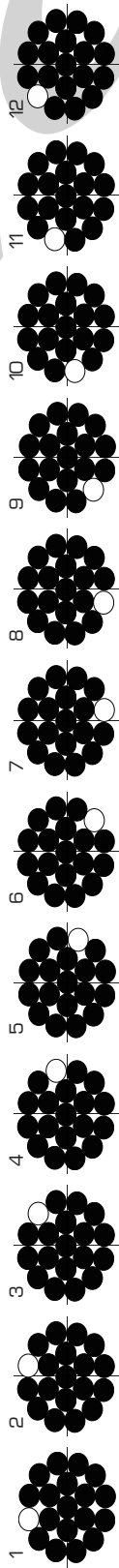

Pattern #7

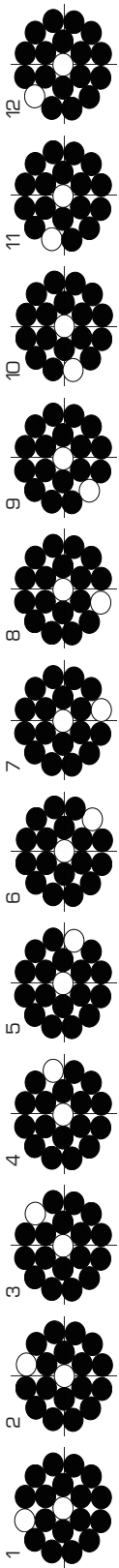

Pattern #8

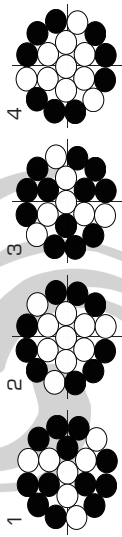

Pattern #9

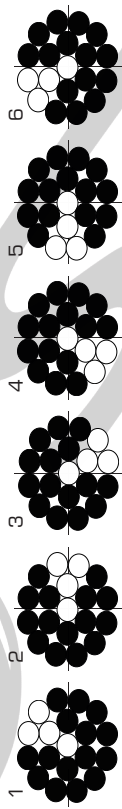

Pattern #10

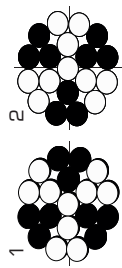

Pattern #11

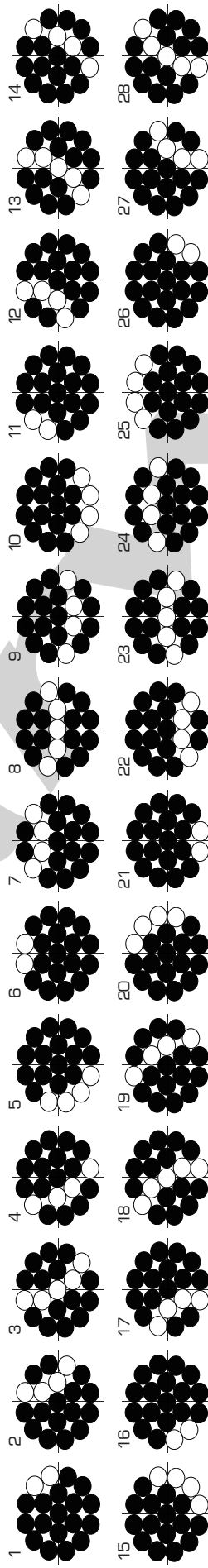

Pattern #12

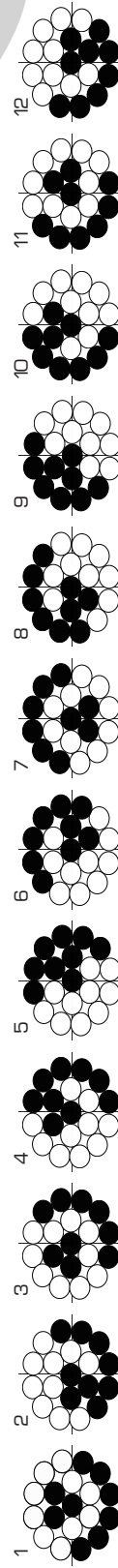

Pattern #12

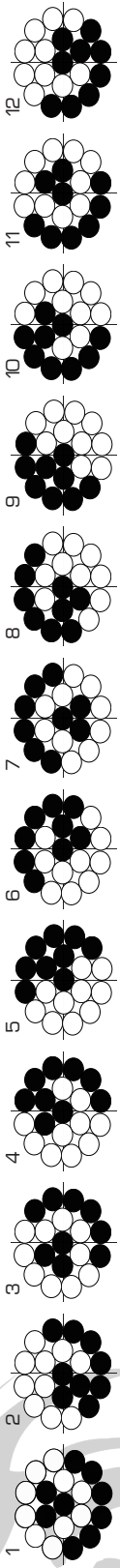

Pattern #13

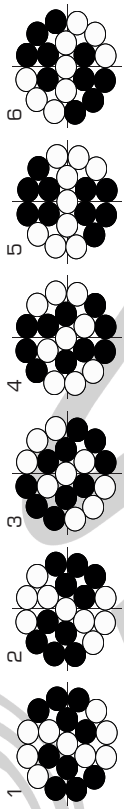

Pattern #14

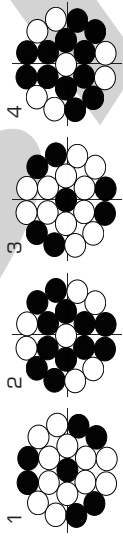

Pattern #15

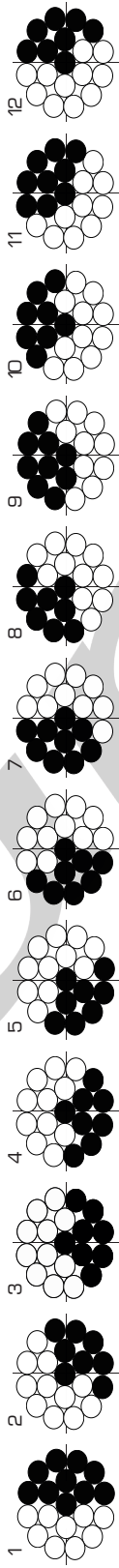

Pattern #16

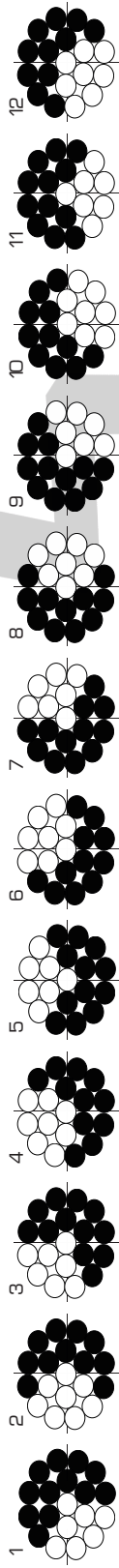

Pattern #17

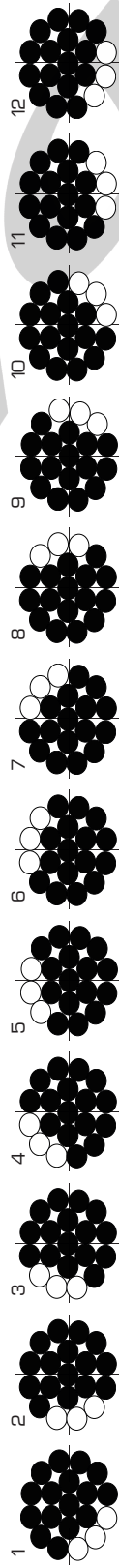

Pattern #18

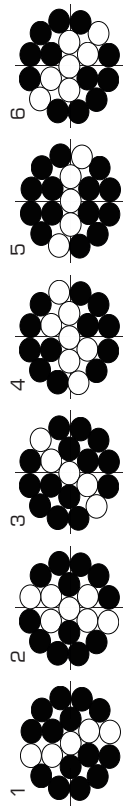

Pattern #19

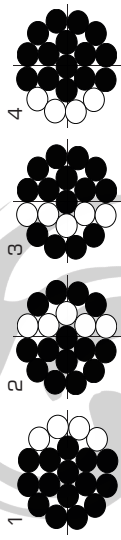

Pattern #20

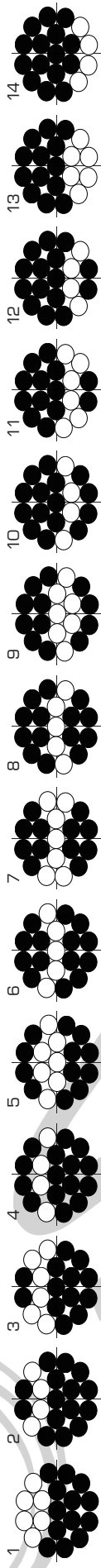

Pattern #21

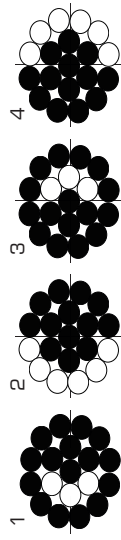

Pattern #22

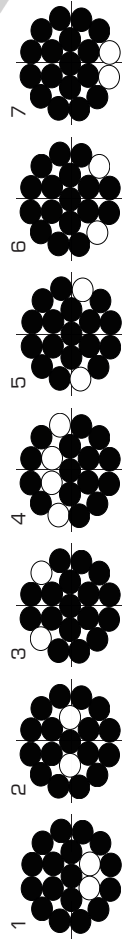

Pattern #23

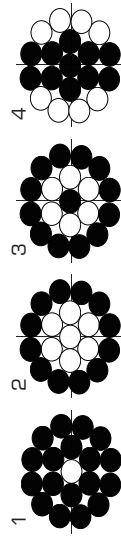

Pattern #24

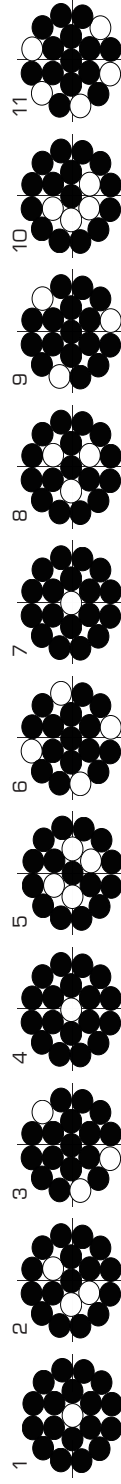

Pattern #25

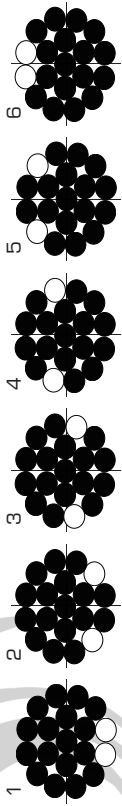

Pattern #26

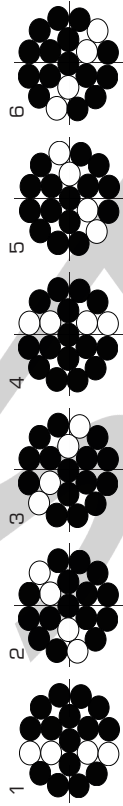

Pattern #27

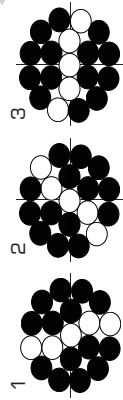

Pattern #28

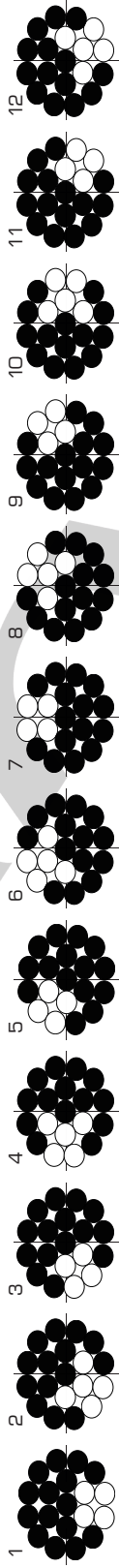

Pattern #29

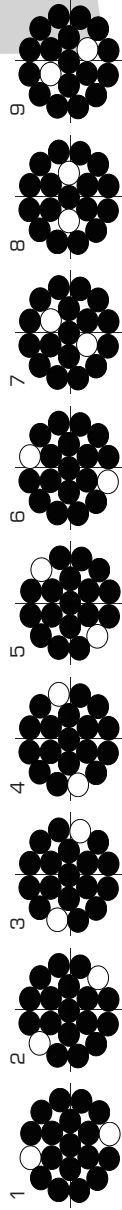

Pattern #30

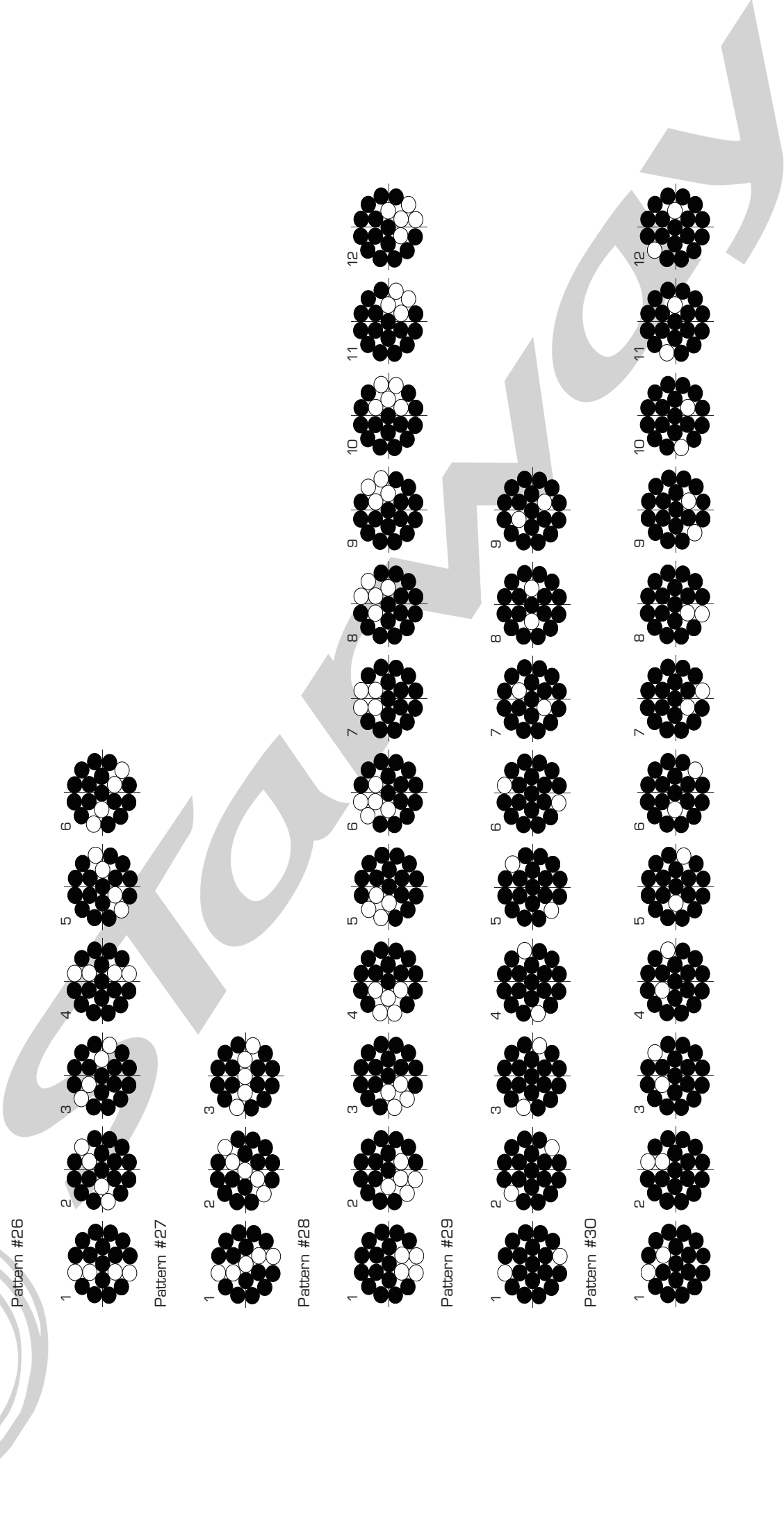
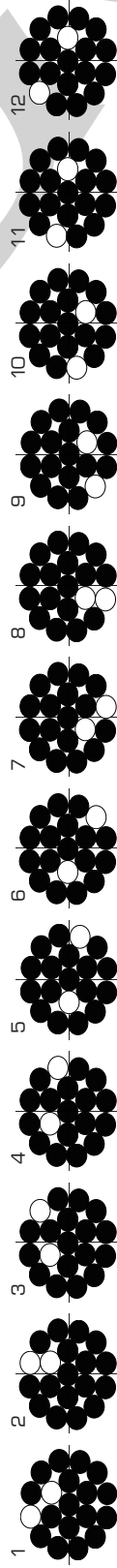

Table of Contents

Technical Specifications	44
Introduction	44
Dimensions.....	44
Regulation Safety.....	45
Spectrometry.....	47
DMX connection.....	50
Menu.....	51
Pixel Layout	52
DMX map.....	53
Virtual Color Wheel	76
Patterns.....	77



TECHNICAL SPECIFICATIONS :

- Zoom 5 ° - 52 ° beam
- Illuminance: 51 500 Lux at 5M / 5 °
- Max flux 11632 Lumens
- Cooling: Forced air 3 modes
- DMX modes: 17/21/25/63/163ch
- Protocols: DMX / Artnet / sACN / Klingnet / RDM
- 30 internal pattern programs
- BColor System
- Flicker Free: Led frequency adjustable from 9000 to 25000Hz
- Dmx In / Out connectors: 2 x XLR5.
- Artnet / sACN / Klingnet connectors: 2 x RJ45
- Dimensions W x D x H: 399MM * 255MM * 406MM
- Net weight: 19Kg with Omega grip.
- Max power: 935W
-

Introduction:

This product has been dedicated for indoor use only. Particularly suitable for scenes. TV set or clubs. Controllable in DMX these projectors can be controlled by any DMX console.

DIMENSIONS (mm) :

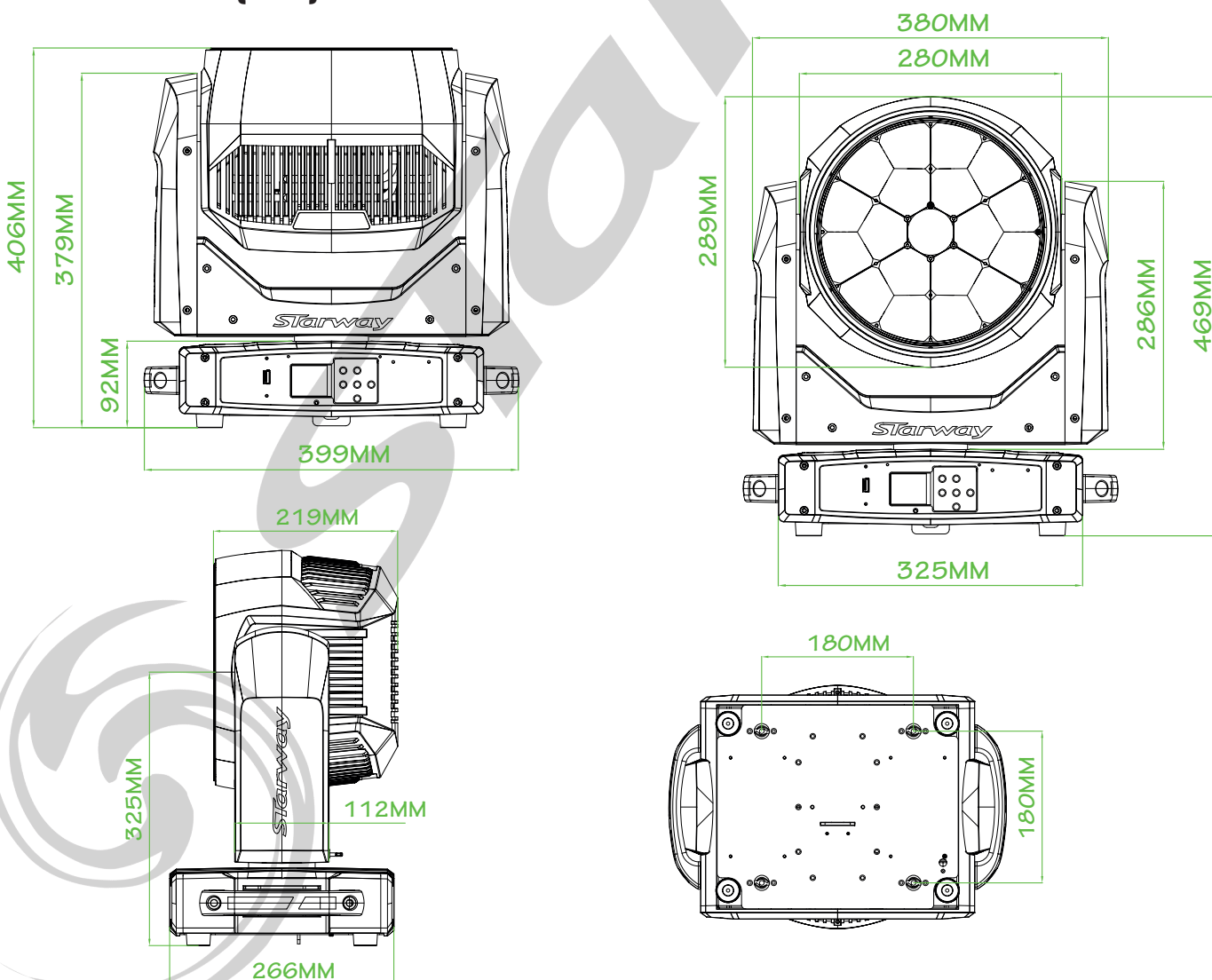



WARNING! Before carrying out any operations with the unit, carefully read this instruction manual and keep it with care for future reference. It contains important information about the installation, usage and maintenance of the unit.



SAFETY

GENERAL INSTRUCTION

- The products referred to in this manual conform to the European Community Directives and are therefore marked with CE:.
- The unit is supplied with hazardous network voltage (230V~). Leave servicing to skilled personnel only. Never make any modifications on the unit not described in this instruction manual, otherwise you will risk an electric shock.
- Connection must be made to a power supply system fitted with efficient earthing (Class I appliance according to standard EN 60598-1). It is, moreover, recommended to protect the supply lines of the units from indirect contact and/or shorting to earth by using appropriately sized residual current devices.
- The connection to the main network of electric distribution must be carried out by a qualified electrical installer. Check that the main frequency and voltage correspond to those for which the unit is designed as given on the electrical data label.
- Never use the fixture under the following conditions:
 - in places wet;
 - in places subject to vibrations or bumps;
 - in places with an ambient temperature of over 45° C.
- Make certain that no inflammable liquids, water or metal objects enter the fixture.
- Do not dismantle or modify the fixture.
- All work must always be carried out by qualified technical personnel. Contact the nearest sales point for an inspection or contact the manufacturer directly.
- If the unit is to be put out of operation definitively, take it to a local recycling plant for a disposal which is not harmful to the environment.

WARNINGS AND INSTALLATION PRECAUTIONS

- Never let the power cord come into contact with other cables! Handle the power cord and all connections with the mains with particular caution!
- Never modify, bend, mechanically strain, put pressure on, pull or heat up the power cord.
- Never strain the cable. There must always be sufficient cable going to the device. Otherwise, the cable will be damaged, which can cause serious damage.
- Never remove warning or informative labels from the unit.
- Never use anything to cover the ground contact.
- Never lift the device holding it by the projector-head, as the mechanics may be damaged
- Do not shake the device. Avoid brute force when installing or operating the device.
- Only operate the device after having checked if the housing is firmly closed and all screws are tightly fastened.
- Only operate the device after having familiarized with its functions.
- Avoid flames and do not put close to flammable liquids or gases.
- Always allow a free air space of at least 0.8 m around the unit for ventilation.
- Always disconnect power from the mains, when device is not used or before cleaning! Only handle the power cord holding it by the plug. Never pull out the plug by tugging the power cord.

- Make sure that the device is not exposed to extreme heat or dust.
- Make sure that the available voltage is not higher than stated on the rear panel.
- Make sure that the power cord is never crimped or damaged. Check the device and the power cord from time to time.
- Make sure that the core diameter of extension cords and power cords is sufficient for the required power consumption of the device.
- Always hold the device by the transport handles.
- Never place any material over the LEDs or lens.
- Never look directly into the light source.
- Never leave any cables lying around.
- Never use the device during thunderstorms, unplug the device immediately.
- Never leave various parts of the packaging (plastic bags, polystyrene foam, nails, etc within children's reach, as they potential sources of danger.
- Do not insert objects into air vents.
- Do not open the device and do not modify the device.
- Do not connect this device to a dimmer pack.
- Do not switch the device on and off in short intervals, as this will reduce the device's life.
- Do not touch the device's housing bare-handed during its operation (housing becomes very hot). Allow the device to cool for at least 5 minutes before handling.
- If the lens or LEDs are obviously damaged, they need to be replaced to prevent their functions from being impaired, due to cracks or deep scratches.
- If the external cable is damaged, it has to be replaced by a qualified technician.
- If device was dropped or struck, disconnect mains power supply immediately. Have a qualified engineer inspect for safety before operating.
- If the device has been exposed to drastic temperature fluctuation (e.g. after transportation), do not switch it on immediately. The arising condensation water might damage your device. Leave the device switched off until it has reached room temperature.
- If your device fails to work properly, discontinue the use immediately. Pack the unit securely (preferably in the original packing material), and return it to your dealer for service.
- For adult use only. The device must be installed beyond the reach of children. Never leave the unit running unattended.
- Never attempt to bypass the thermostatic switch or fuses.
- For replacement use fuses of same type and rating only.
- This device is heavy. When handling, use a two-person lift to prevent injury.
- The user is responsible for correct positioning and operating of the device. The manufacturer will not accept liability for damages caused by the misuse or incorrect installation of this device.
- This device falls under protection class I. Therefore it is essential to connect the yellow/green conductor to earth.
- Repairs, servicing and electric connection must be carried out by a qualified technician.

Rigging

This device is heavy. When handling, use a two-person lift to prevent injury. Please follow the European and national guidelines concerning rigging, trussing and all other safety issues.

SPECTROMETRY

Distance 5 meters		
Color	Wave Length	Lux
Red	637 nm	8377 lux
Green	516 nm	15521 lux
Blue	443 nm	4112 lux
White		25146 lux
RGBW LEDs 5°		51500 lux
RGyBW LEDs 52°		1691 lux

MEASUREMENTS MADE WITH *USPECTRUM MK305S*

RED LED

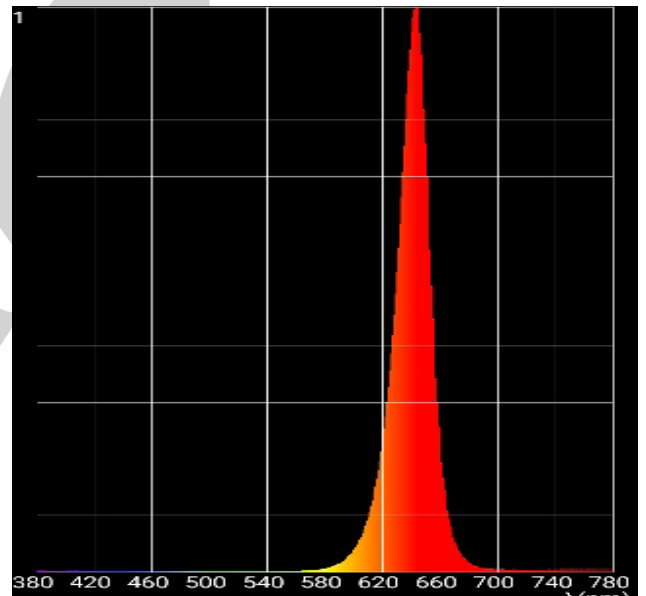
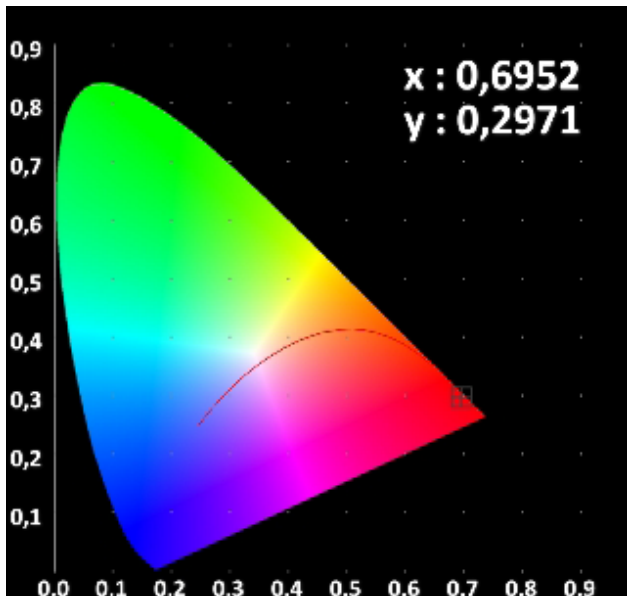

GREEN LED

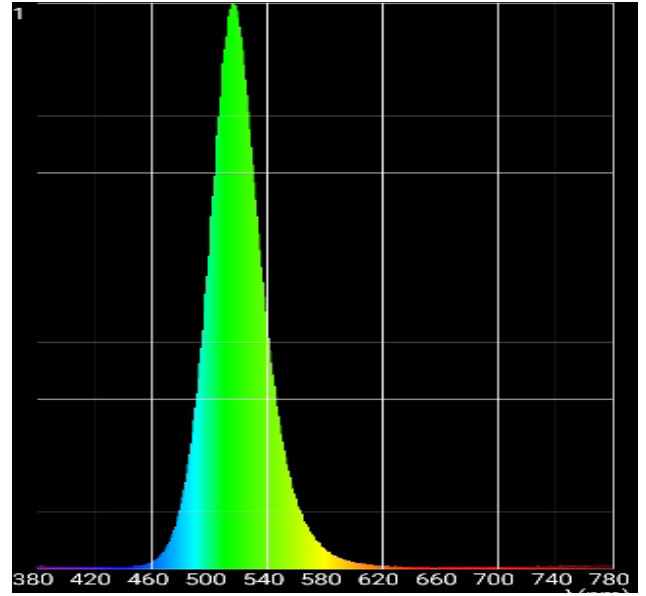
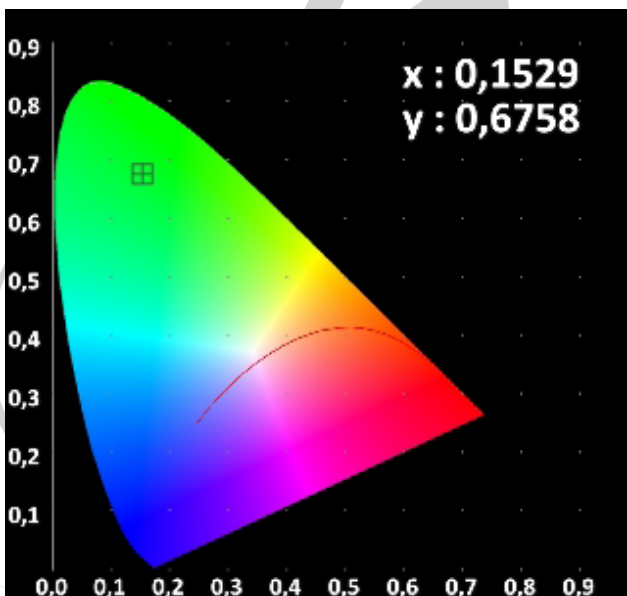

BLUE LED

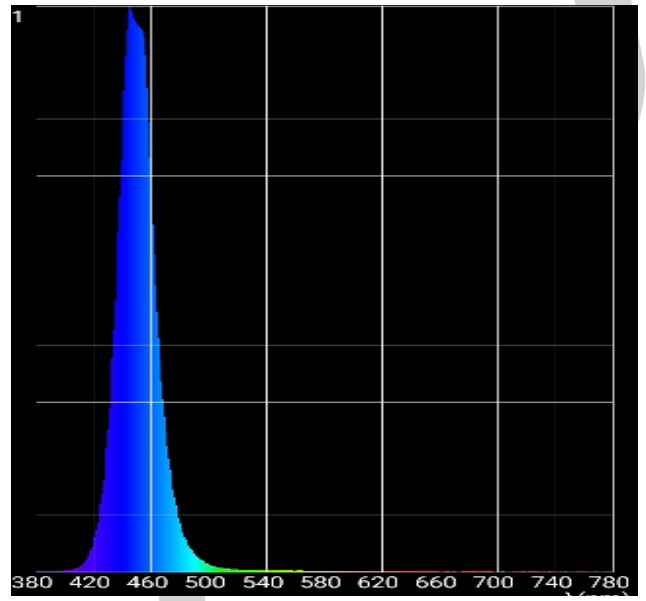
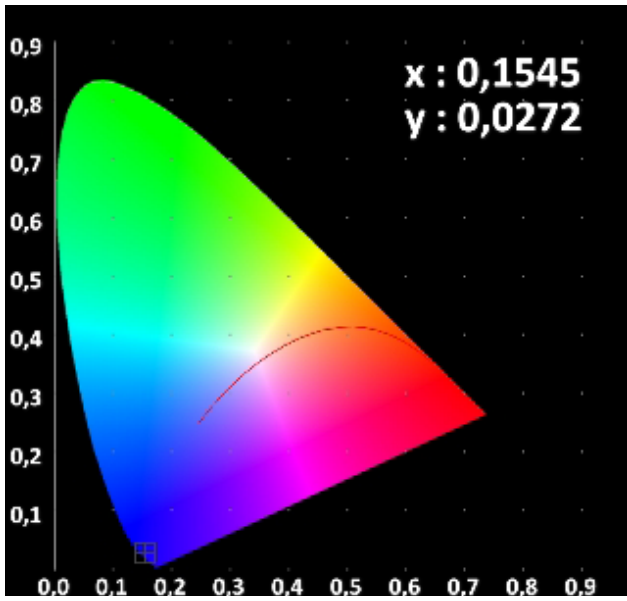

WHITE LED

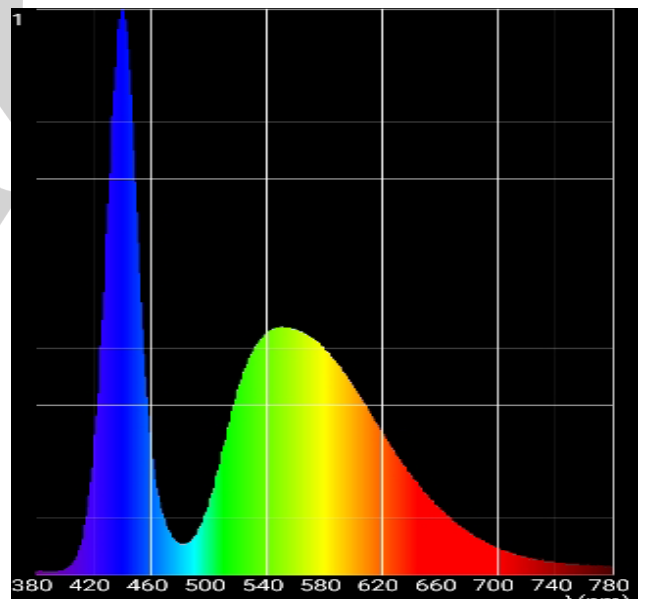
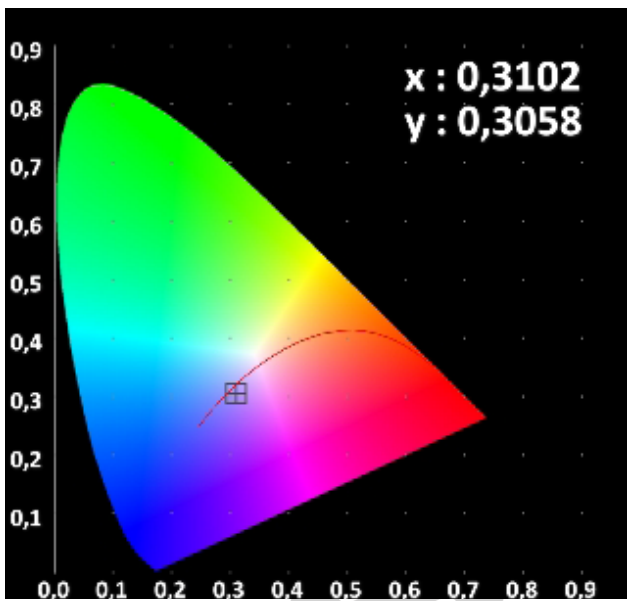

MINIMUM ANGLE

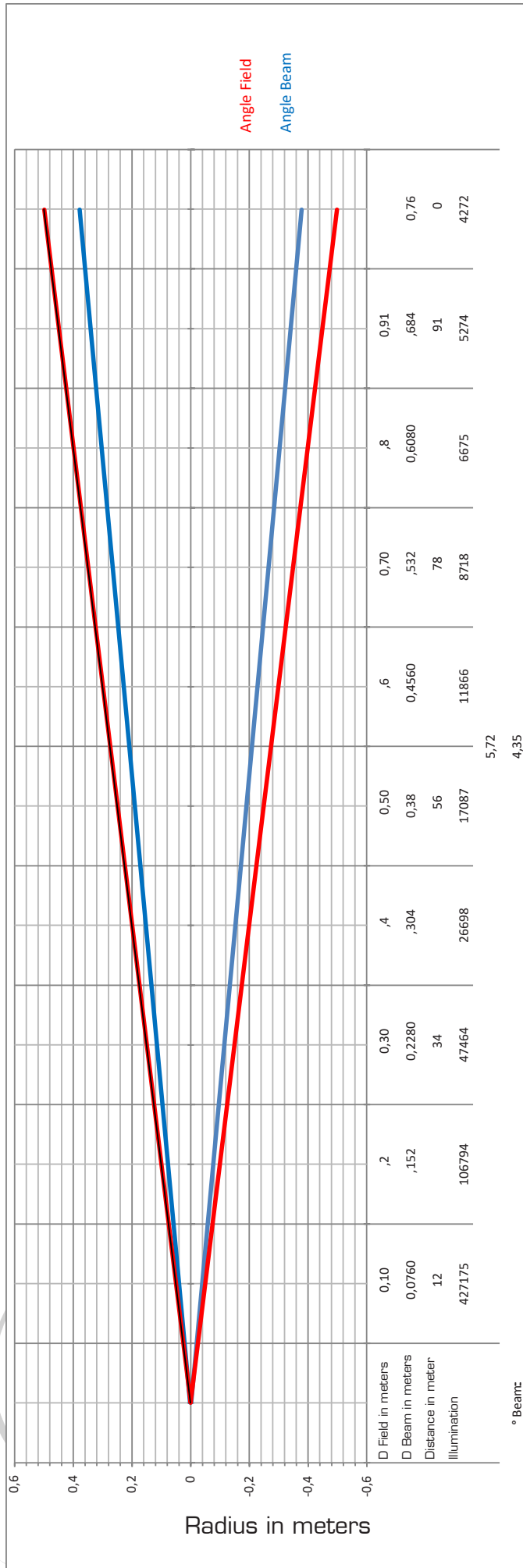

MAXIMUM ANGLE

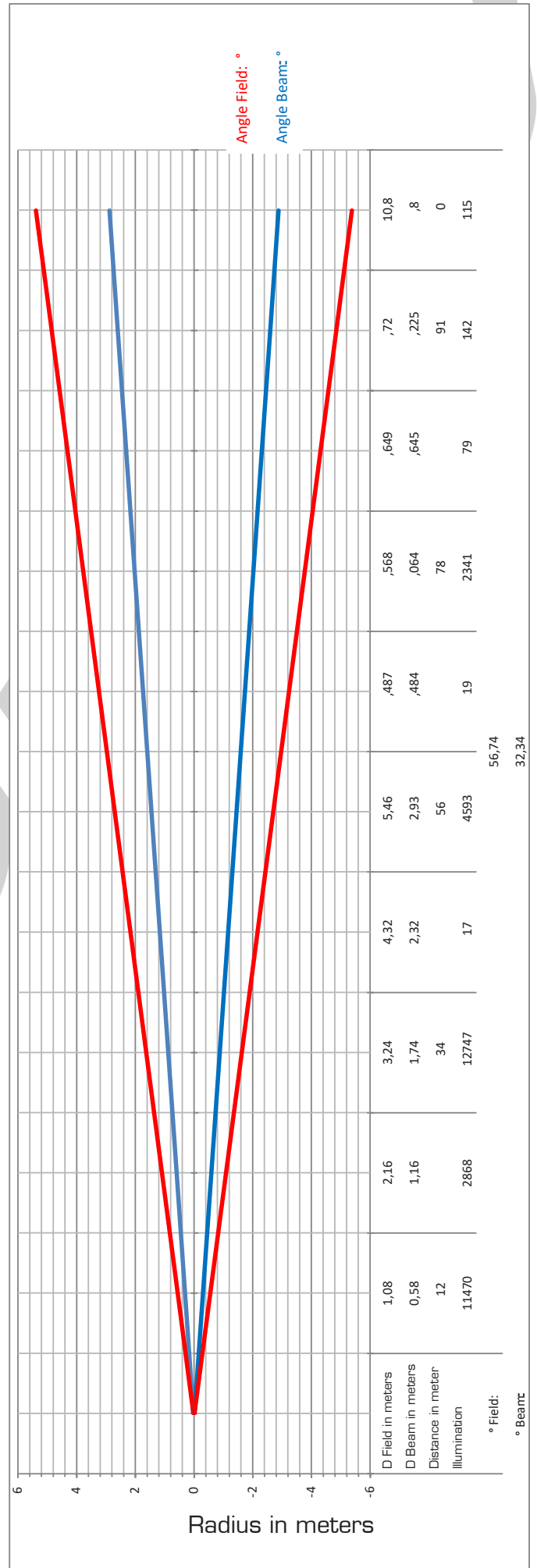

DMX CONNECTION

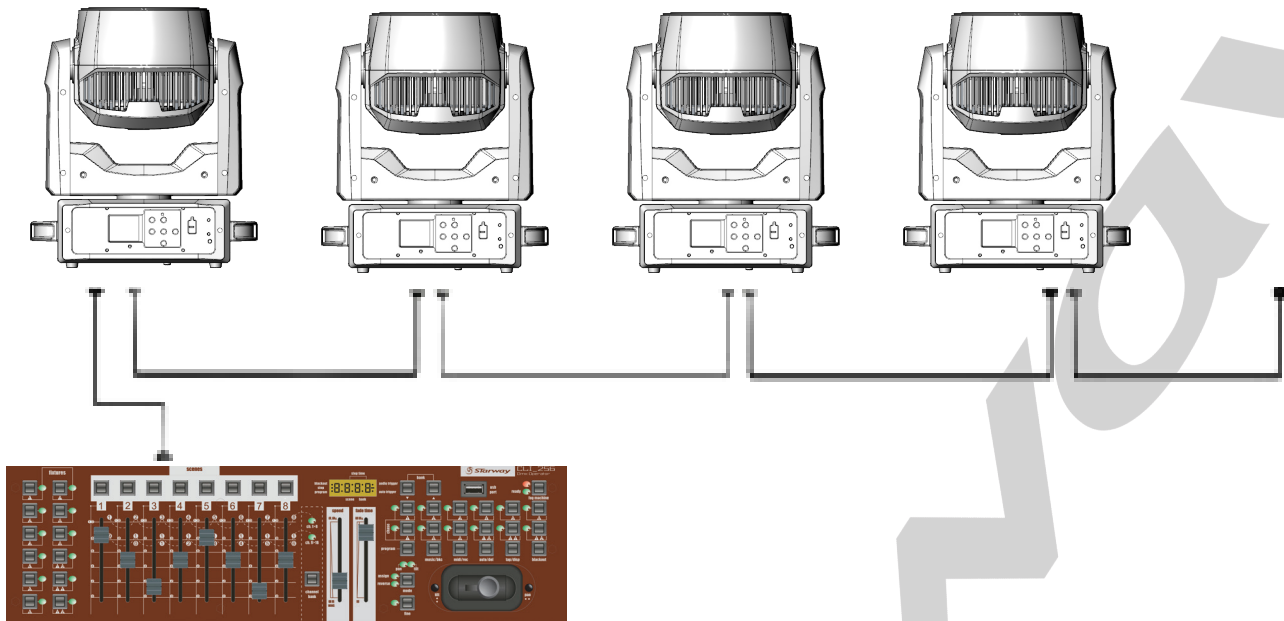

The projectors are connected in series to a DMX console. Connect the projectors as shown in the diagram above.

- Connect the male side of the DMX cable to the output of the DMX512 console.
- Then connect the DMX output of the projector to the input of the next projector.
- Repeat the operation on the whole chain.

The use of a termination plug is strongly recommended. In some cases the absence of this termination is not problematic, on the other hand its presence is very strongly recommended in disturbed spaces (Stage, long line length, TV studio etc.). Its value is generally 120 Ohms. The plug is an XLR male plug into which a resistance of 120 Ohms $\frac{1}{4}$ of W. is welded between 2 and 3. This plug prevents the reflection of information transmitted when using long lengths of cable.

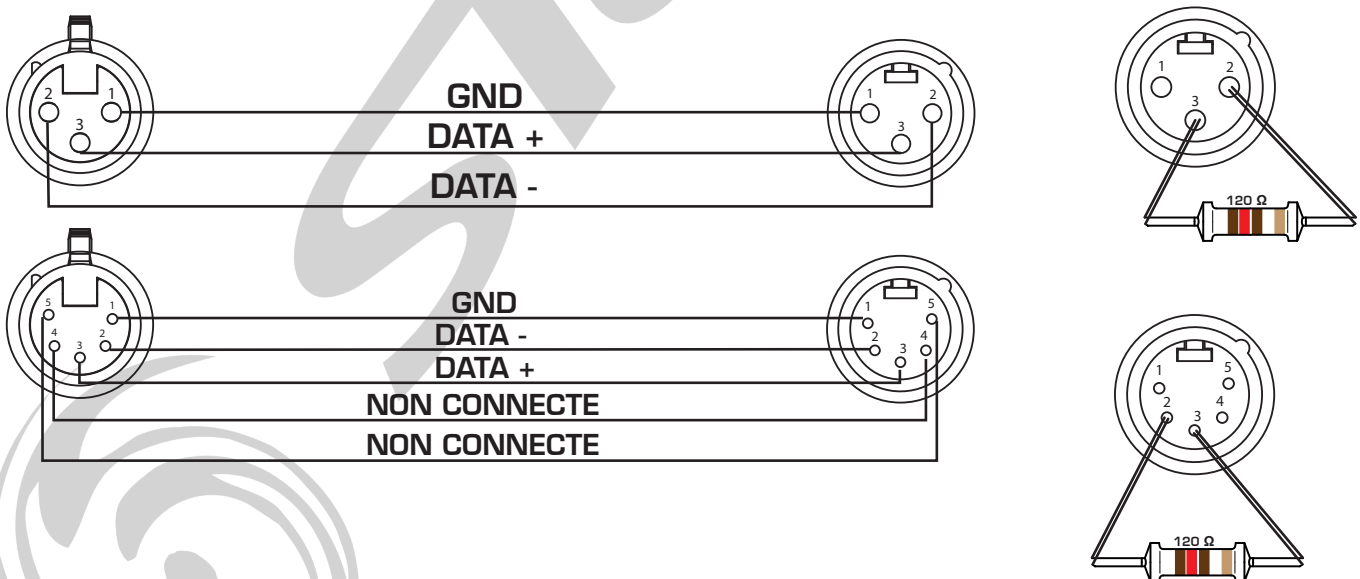

MENU

THE VALUES IN **RED** ARE DEFINED BY DEFAULT IN THE MENU
AND RELOADED AS IN THE CASE OF
«RELOAD DEFAULT SETTINGS»

Receive	Adress mode	1 address	This choice is only 1 address
		2 address	This choice is 2 address
	Set Address	Adress Fixture	A001~AXXX
		Address Leds	A001~AXXX
User Mode	User Mode	Basic 8B	
		Basic 16B	
		Standard 8B	
		Standard 16B	
		Pixel 8B	
		Pixel 16B	
		User A	
		User B	
		User C	
	Edit A	Max Chan PAN, TILT, .../...	
	Edit B		
	Edit C		
	Function	Status	No DMX Mode
P.Reverse			ON/ OFF
T.Reverse			ON/ OFF
Pan Degree			630/ 540
Feedback			ON /OFF
Move.Spd			Speed 1 ~ 4
Hibernation			OFF , 01M~99M, 15M
Fixture ID		ServicePIN	000-255 (050)
		Universe	000-255
		Pin Code: 050 UnitIPAddr	002.000.000.002
		Mask Addr	255.000.000.000
Protocol Set		ArtNet	
		sACN	
KlingNet		Enable /Disable	
Net Switch		On /Off	
Dim Mode		Standard /Stage/TV/Architectural/Theatre	
Temp. C/F		Celsius	
		Fahrenheit	
Dim Curve		LINEAR	
		Square	
		Exp	
		Log	
		S-CURVE	
Frequency		900HZ /1000HZ/1100HZ/1200HZ/1300HZ/ 1400HZ/1500HZ/2500HZ/4000HZ/5000HZ/ 10KHZ/15KHZ/20KHZ/25KHZ	

Function	Fan Set	Head Fan	Auto	
			High	
			Silent	
	LCD.Set	Backlight	02~60m <05m>	
		FlipDisplay	ON/ OFF	
		Key Lock	ON/ OFF	
		DispFlash	ON /OFF	
	Disp.Set	Chan.Value	PAN, TILT,	
		Slave Set	Slave1, Slave2, Slave3	
		Auto.Prog	Master / Alone	
	DFSE	ON/ OFF		
	USB Update	ON/ OFF		
	Wireless	W-DMX	ON/ OFF	
		Tx/Rx	Transmit /Receive	
		Protocol	G3 / G4S	
		Tx/Rx Link	Link / UnLink	
Rx Reset		NO /YES		
Information	Time.Info	CurrentTime	(Hours)	
		Total Time	(Hours)	
		Last Time	(Hours)	
		Timer PIN	Clear last Password=050, Clear total Password=060	
			Clear Last	ON/OFF
			Clear Total	
	Temp. Info	XXXX		
	Fan Speed	Fan : xxxxRPM		
	Error. Info	NONE/Pan,Tilt.....		
	Model. Info	MODENA		
	Software.Ver- sion	1U01 Vx.x.x 2U01 Vx.x.x 3U01 Vx.x.x 4U01 Vx.x.x 5U01 Vx.x.x 6U01 Vx.x.x		
Test	Reset.Motor	All		
		Pan&Tilt		
		Head		
	Test.Channel	PAN, TILT,		
	Panel.Ctrl.	PAN =XXX		
		TILT=XXX		
		.../...		
	Calibrate	Password - 050		
		PAN		
		TILT		
.../...				

RECEIVE

Address Mode :

To facilitate the design of LED arrays with entry-level DMX lighting desk, it is possible to address the Daytona in the classic way (all channels are addressed contiguously). Or to select a first address for the general parameters of the projector and a second for the matrix of LEDs.

Set Address :

Configuration of the Daytona DMX address

USER MODE

User Mode :

Selection of the DMX mode of the Daytona between the different modes such as:

- Basic 8B - 17 channels DMX - Leds Mode 8 Bits
- Basic 16B - 21 channels DMX - Leds Mode 16 Bits
- Standard 8B - 21 channels DMX - Leds Mode 8 Bits
- Standard 16B - 25 channels DMX - Leds Mode 16 Bits
- Pixel 8B - 93 channels DMX - Leds pixel/pixels 8 Bits
- Pixel 16B - 163 channels DMX - Leds pixel/pixels 16 Bits
- User A - User mode 1
- User B - User mode 2
- User C - User mode 3

Edit A ; Edit B ; Edit C

In this sub-menu it is possible to create 3 channel assignments at the discretion of the user. In each "Edit A; Edit B and Edit C "it is possible to select the maximum number of channels, and to change the order of the DMX channels.

FUNCTION

Status

In this sub-menu it is possible to modify the behavior of the Daytona.

No DMX Mode : Modification of the Daytona reaction during DMX signal loss :

- Hold : Hold the last DMX values received
- Auto : The Daytona switches to Auto mode
- Black : The Daytona goes into «Stand By» mode

P Reverse : ON/OFF - Pan inversion

T Reverse : ON/OFF - Tilt inversion

PAN degree : 630° or 540° - Selection of the maximum angle of PAN

Feedback : ON/OFF - Activation or Deactivation of motors feedback

Move Speed : Selection of movement speed between 1 and 4
1 - faster to 4 - slower

Hibernation

If there is no signal, the projector will go into standby mode until the signal returns:
OFF - 01 Min to 99 Min - Selection of the Daytona hibernation mode.
OFF by default or from 1 minute to 99 minutes before switching to hibernation mode.

Fixture ID

Sub-menu allowing the modification of the receiving DMX universe (ArtNet and sACN) as well as Daytona's IP address and the subnet mask. To unlock this sub menu insert the **Pin Code 050**

Universe: 0-255 - Selection of the DMX receiving universe

UnitIPAddr: xxx.xxx.xxx.xxx - Selection of the Daytona IP address

MaskAddr: xxx.xxx.xxx.xxx - Selection of the Daytona subnet mask

Protocol Set

Sub-menu allowing the selection of the Daytona network protocol:
Artnet (by default) or sACN

KlingNet

Submenu allowing KlingNet protocol activation or not:
Enable (default) or Disable

Net Switch

Sub-menu allowing the activation or deactivation of Daytona's Ethernet switch

Dim Speed

Sub-menu allowing the dimmer's smoothing choice between Standard (default), Stage, TV, Architectural or Theater.

Temp C°/F°

Sub-menu for selecting the Celsius (default) or Fahrenheit system, for displaying the temperature.

Dim Curve

Submenu allowing the selection of the dimmer curve between Linear (default), Square, Exp, Log and S-Curve.

Frequen

Sub-menu allowing the selection of the refresh rate of the LED to avoid a possible «flicking» during video filming. Changeable value between 900Hz (default) and 25Khz.

Fan Set - Head Fan

Sub-menu for selecting the head fan behavior between Auto (default) and Low or High.

LCD Set

Sub-menu allowing to select the behavior of Daytona's display.

Backlight - 02m to 60m - Selection of the display backlight retention time (without menu manipulation) from 2 minutes to 60 minutes. Time set to 5 minutes by default.

Flip Display - ON / OFF - Reversal of the display direction

KeyLock - ON / OFF - Locking of the Daytona's buttons.

DispFlash - ON / OFF - Activation or not of the display flash when the Daytona does not receive a DMX signal.

Disp.Set

Chan.Value - continuous display of DMX values of all channels.

Slave Set - Selection of Daytona slave mode to "offset" Daytona when using Master / Slave mode - between Slave 1, Slave2 and Slave 3.

Auto Prog - Master / Slave mode selection:

In MASTER mode, master Daytona transmits the information to all Daytona connected using a DMX cable and where Slave mode has been activated in the "Slave Set" submenu

In ALONE mode Daytona does not transmit information and executes its AUTO mode individually.

DFSE - ON/OFF - Reloading the Daytona default settings.

USB Update - ON/OFF - Daytona firmware update.



DAYTONA FIRMWARE UPDATE

1. Place the update files in a directory on the USB key, for example Modena:

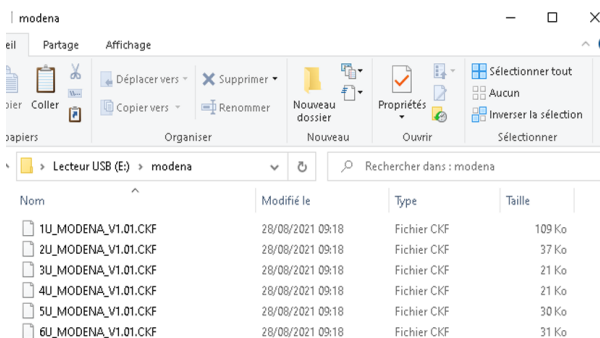

2. Turn on the projector and go to the menu by pressing "Mode" > "Function" > "USB Update" > "On", exit the menu and turn off the projector.
3. Projector off, DMX and ARTnet disconnected, insert the USB key into the connector located on the front panel.
4. Turn on the projector > the screen displays the available directories> select «Daytona»

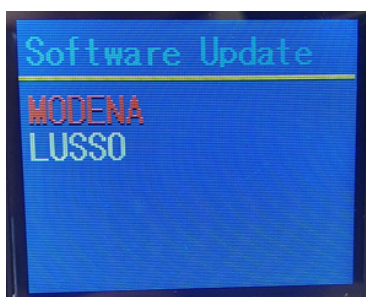

5. Select «Start» and press «Enter»

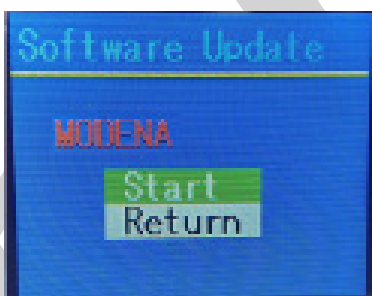

6. The update process starts and will upgrade each electronic board.
The projector will perform a reset at the end of the process

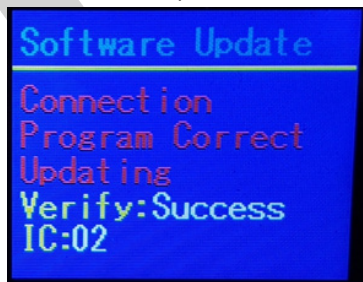

7. Remove the key and check the software versions by pressing «Mode» > «Information» > «Software. V» > «Enter»

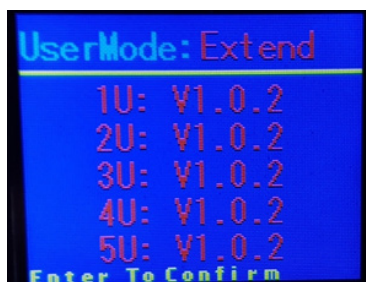

8. Go to the menu by pressing "Mode" > "Function" > "USB Update" > "OFF", exit the menu.

Wireless

W-DMX

Sub-menu allowing the activation or deactivation of the Wireless Solution module

Tx/Rx

Sub-menu to select the mode of the Wireless Solution module, either Receiver or Transmitter mode.

Protocol:

Sub-menu to select the transmission mode of the Wireless Solution module, either in G3 mode (Legacy mode) or in G4S mode

Tx/Rx Link:

Sub-menu for pairing (Link) or unpairing (Unlink) projectors / receivers when DAYTONA is in Transmitter mode

RX Reset:

Sub-menu for unpairing DAYTONA and placing it in "waiting for pairing" mode when it is in Receiver mode.

INFORMATION

Time.Info

CurrentTime: Display of the usage time (in hours) since the last power on

TotalTime: Display of the usage time (in hours) since the first power-up.

LastTime: Display of the usage time (in hours) since the last reset.

Time PIN: To access the reset of usage times you must enter a PIN code:

050 to reset the "Last Time"

060 to reset the "TotalTime"

ClearLast: ON / OFF to reset

ClearTOTAL: ON / OFF to reset

Temp.Info - Temperature display

xxx F or C - Temperature display

Fan Speed - Fan speed display

Fan : xxx RPM

Error.Info - Display of the last 10 error messages.

Model.Info - Display of model name : Daytona

Software.V - Display of the version of the various processors

1U01 - Vx.x.x

2U01 - Vx.x.x

3U01 - Vx.x.x

4U01 - Vx.x.x

5U01 - Vx.x.x

6U01 - Vx.x.x

MENU TEST

Reset Motors

ALL : Reset of all motors

Pan&Tilt : Reset of Pan and Tilt motors

Head : Zoom reset

Test.Channel

Sub-menu allowing you to test all Daytona parameters such as:

Pan, Pan Fine, Tilt, Tilt Fine, Red, Red Fine, Green, Green Fine, Blue, Blue Fine, White, White Fine, Strobe, Dimmer, Dim Fine, Zoom, DimMode, P/T Speed, Reset/Prog

Panel.Ctrl.

Submenu allowing manual control of all Daytona parameters such as:

Pan, Pan Fine, Tilt, Tilt Fine, Red, Red Fine, Green, Green Fine, Blue, Blue Fine, White, White Fine, Strobe, Dimmer, Dim Fine, Zoom, DimMode, P/T Speed, Reset/Prog

Calibrate :

Sub-menu allowing to recalibrate the motors and the LEDs

To access this menu you must enter the PIN code to unlock this function.

Pin Code: 050

This gives you access to the following parameters:

Pan, Pan Fine, Tilt, Tilt Fine, Red, Red Fine, Green, Green Fine, Blue, Blue Fine, White, White Fine, Strobe, Dimmer, Dim Fine, Zoom.

PIXEL LAYOUT

DISPLAY FRONT VIEW, PAN VALUE : 128 - TILT VALUE : 032

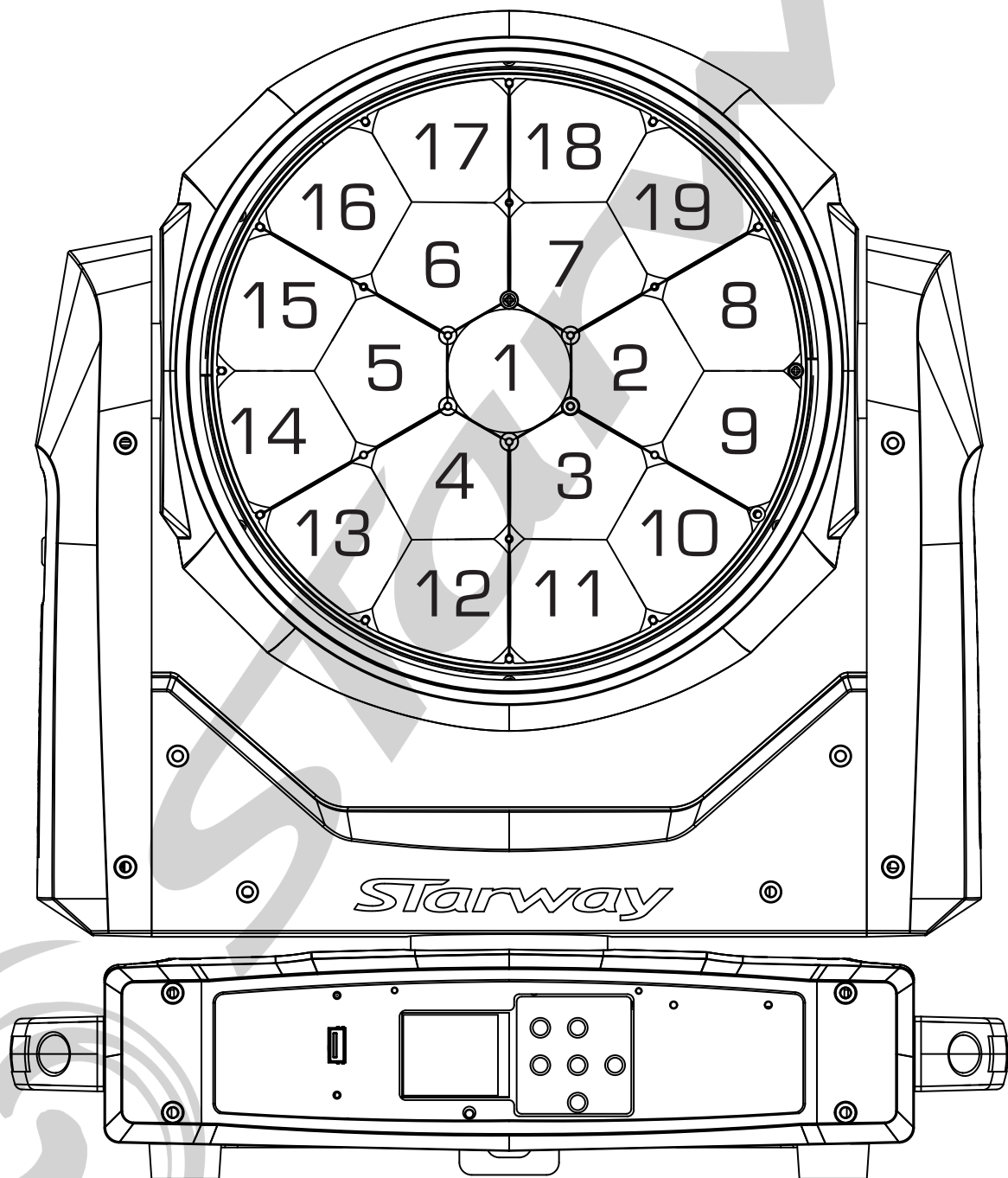

DMX MAP

BASIC 8B Mode

CH	Feature	Value	Description	Information
1	Pan	000 - 255	Pan	
2	Pan fine	000 - 255		
3	Tilt	000 - 255	Tilt	
4	Tilt fine	000 - 255		
5	P/T Speed	000 - 225	Max to min speed	
		226 - 235	Blackout by movement	
		236 - 255	Idle	
6	Dimmer	000 - 255	Dimmer	
7	Dimmer Fine	000 - 255	Dimmer Fine	
8	Strobe	000 - 009	Shutter Closed	
		010 - 019	Shutter open	
		020 - 068	Strobe effect slow to fast	
		069 - 079	Shutter open	
		080 - 128	Pulse - effect in sequences	
		129 - 139	Shutter open	
		140 - 188	Random strobe effect slow to fast	
		189 - 199	Shutter open	
		200 - 248	Random flash Pixel slow to fast	
		249 - 255	Shutter open	
9	Red	000 - 255	Red	
10	Green	000 - 255	Green	
11	Blue	000 - 255	Blue	
12	White	000 - 255	White	
13	Virtual Color Wheel	000 - 010	White macro	RGBW channels need to are at 255 value to obtain the good color temperature. Is possible to ajust the color with RGBW
		011 - 012	Tungsten Emulation 3200°K	
		013 - 014	Tungsten Emulation 4000°K	
		015 - 016	Tungsten Emulation 4500°K	Only W channel can modify the color saturation
		017 - 250	Virtual color wheel	
		251 - 253	CW Virtual Color Wheel rotation	
254 - 255	CCW Virtual Color Wheel rotation			
14	Colour Fade/Speed	000 - 255	Fade between Virtual colors/ Speed from fast to slow.	
15	Zoom	000 - 255	Zoom	Narrow to Wide
16	Dim Modes	000 - 020	Default unit setting	
		021 - 040	Standard	
		041 - 060	Stage	
		061 - 080	TV	
		081 - 100	Architectural	
		101 - 255	Theatre	

17	Control	000 - 004	Idle	
		005 - 009	Invert Pan on (Hold 3s)	
		010 - 014	Invert Pan off (Hold 3s)	
		015 - 019	Invert Tilt on (Hold 3s)	
		020 - 024	Invert Tilt off (Hold 3s)	
		025 - 029	Fan Silent (Hold 3s)	The fan turn always at same low speed
		030 - 034	Fan Auto (Hold 3s)	The fan speed increase with temp
		035 - 039	Fan High (Hold 3s)	The fan turn always at same high speed
		040 - 089	Idle	
		090 - 101	Linear Dimmer Curve (hold 3s)	
		102 - 113	Square Dimmer Curve (hold 3s)	
		114 - 125	Inv - Square Dimmer Curve (hold 3s)	
		126 - 131	S - Dimmer Curve (hold 3s)	
		132 - 137	Led Freq. 900 Hz (hold 3s)	
		138 - 143	Led Freq. 1000 Hz (hold 3s)	
		144 - 149	Led Freq. 1100 Hz (hold 3s)	
		150 - 155	Led Freq. 1200 Hz (hold 3s)	
		156 - 161	Led Freq. 1300 Hz (hold 3s)	
		162 - 167	Led Freq. 1400 Hz (hold 3s)	
		168 - 173	Led Freq. 1500 Hz (hold 3s)	
		174 - 179	Led Freq. 2500 Hz (hold 3s)	
		180 - 185	Led Freq. 4000 Hz (hold 3s)	
		186 - 191	Led Freq. 5000 Hz (hold 3s)	
		192 - 197	Led Freq. 10000 Hz (hold 3s)	
		198 - 203	Led Freq. 15000 Hz (hold 3s)	
		204 - 209	Led Freq. 20000 Hz (hold 3s)	
		210 - 215	Led Freq. 25000 Hz (hold 3s)	
		216 - 218	Reset Pan/Tilt (Hold 3s)	
		219 - 221	Reset only Head (Hold 3s)	
		222 - 224	Reset All Functions (Hold 3s)	
		225 - 234	Idle	
		235 - 237	Klingnet Disable	The leds are controlled only by the dmx or Artnet
		238 - 240	Leds controled Klingnet only	The leds are controlled only by the Klingnet
241 - 243	Leds controled Klingnet + Dmx	The leds are controlled by the Klingnet but the dmx has priority over RGBW		
244 - 246	Klingnet Calibration OFF	So that the Klingnet white is matched with for example an Led screen, it is possible to calibrate it in the Modena calibration menu. This calibration can be activated or not from the console.		
247 - 249	Klingnet Calibration ON	So that the Klingnet white is matched with for example an Led screen, it is possible to calibrate it in the Modena calibration menu. This calibration can be activated or not from the console		
250 - 255	Idle			

BASIC 16B Mode

CH	Feature	Value	Description	Information
1	Pan	000 - 255	Pan	
2	Pan fine	000 - 255		
3	Tilt	000 - 255	Tilt	
4	Tilt fine	000 - 255		
5	P/T Speed	000 - 225	Max to min speed	
		226 - 235	Blackout by movement	
		236 - 255	Idle	
6	Dimmer	000 - 255	Dimmer	
7	Dimmer Fine	000 - 255	Dimmer Fine	
8	Strobe	000 - 009	Shutter Closed	
		010 - 019	Shutter open	
		020 - 068	Strobe effect slow to fast	
		069 - 079	Shutter open	
		080 - 128	Pulse - effect in sequences	
		129 - 139	Shutter open	
		140 - 188	Random strobe effect slow to fast	
		189 - 199	Shutter open	
		200 - 248	Random flash Pixel slow to fast	
249 - 255	Shutter open			
9	Red	000 - 255	Red	
10	Red Fine	000 - 255		
11	Green	000 - 255	Green	
12	Green Fine	000 - 255		
13	Blue	000 - 255	Blue	
14	Blue Fine	000 - 255		
15	White	000 - 255	White	
16	White Fine	000 - 255		
17	Virtual Color Wheel	000 - 010	White Macro	RGBW channels need to be at 255 value to obtain the good color temperature. Is possible to adjust the color with RGBW
		011 - 012	Tungsten Emulation 3200°K	
		013 - 014	Tungsten Emulation 4000°K	
		015 - 016	Tungsten Emulation 4500°K	Only W channel can modify the color saturation
		017 - 250	Virtual color wheel	
		251 - 253	CW Virtual Color Wheel rotation	
254 - 255	CCW Virtual Color Wheel rotation			
18	Colour Fade/ Speed	000 - 255	Fade between Virtual colors/ Speed from fast to slow.	
19	Zoom	000 - 255	Zoom	Narrow to Wide
20	Dim Modes	000 - 020	Default unit setting	
		021 - 040	Standard	
		041 - 060	Stage	
		061 - 080	TV	
		081 - 100	Architectural	
		101 - 255	Theatre	

21	Control	000 - 004	Idle	
		005 - 009	Invert Pan on (Hold 3s)	
		010 - 014	Invert Pan off (Hold 3s)	
		015 - 019	Invert Tilt on (Hold 3s)	
		020 - 024	Invert Tilt off (Hold 3s)	
		025 - 029	Fan Silent (Hold 3s)	The fan turn always at same low speed
		030 - 034	Fan Auto (Hold 3s)	The fan speed increase with temp
		035 - 039	Fan High (Hold 3s)	The fan turn always at same high speed
		040 - 089	Idle	
		090 - 101	Linear Dimmer Curve (hold 3s)	
		102 - 113	Square Dimmer Curve (hold 3s)	
		114 - 125	Inv - Square Dimmer Curve (hold 3s)	
		126 - 131	S - Dimmer Curve (hold 3s)	
		132 - 137	Led Freq. 900 Hz (hold 3s)	
		138 - 143	Led Freq. 1000 Hz (hold 3s)	
		144 - 149	Led Freq. 1100 Hz (hold 3s)	
		150 - 155	Led Freq. 1200 Hz (hold 3s)	
		156 - 161	Led Freq. 1300 Hz (hold 3s)	
		162 - 167	Led Freq. 1400 Hz (hold 3s)	
		168 - 173	Led Freq. 1500 Hz (hold 3s)	
		174 - 179	Led Freq. 2500 Hz (hold 3s)	
		180 - 185	Led Freq. 4000 Hz (hold 3s)	
		186 - 191	Led Freq. 5000 Hz (hold 3s)	
		192 - 197	Led Freq. 10000 Hz (hold 3s)	
		198 - 203	Led Freq. 15000 Hz (hold 3s)	
		204 - 209	Led Freq. 20000 Hz (hold 3s)	
		210 - 215	Led Freq. 25000 Hz (hold 3s)	
		216 - 218	Reset Pan/Tilt (Hold 3s)	
		219 - 221	Reset only Head (Hold 3s)	
		222 - 224	Reset All Functions (Hold 3s)	
		225 - 234	Idle	
		235 - 237	Klingnet Disable	The leds are controlled only by the dmx or Artnet
238 - 240	Leds controled Klingnet only	The leds are controlled only by the Klingnet		
241 - 243	Leds controled Klingnet + Dmx	The leds are controlled by the Klingnet but the dmx has priority over RGBW		
244 - 246	Klingnet Calibration OFF	So that the Klingnet white is matched with for example an Led screen, it is possible to calibrate it in the Modena calibration menu. This calibration can be activated or not from the console.		
247 - 249	Klingnet Calibration ON	So that the Klingnet white is matched with for example an Led screen, it is possible to calibrate it in the Modena calibration menu. This calibration can be activated or not from the console		
		250 - 255	Idle	

STANDARD 8B Mode

CH	Feature	Value	Description	Information
1	Pan	000 - 255	Pan	
2	Pan fine	000 - 255		
3	Tilt	000 - 255	Tilt	
4	Tilt fine	000 - 255		
5	P/T Speed	000 - 225	Max to min speed	
		226 - 235	Blackout by movement	
		236 - 255	Idle	
6	Dimmer	000 - 255	Dimmer	
7	Dimmer Fine	000 - 255	Dimmer Fine	
8	Strobe	000 - 009	Shutter Closed	
		010 - 019	Shutter open	
		020 - 068	Strobe effect slow to fast	
		069 - 079	Shutter open	
		080 - 128	Pulse - effect in sequences	
		129 - 139	Shutter open	
		140 - 188	Random strobe effect slow to fast	
		189 - 199	Shutter open	
		200 - 248	Random flash Pixel slow to fast	
249 - 255	Shutter open			
9	Red	000 - 255	Red	
10	Green	000 - 255	Green	
11	Blue	000 - 255	Blue	
12	White	000 - 255	White	
13	Foreground Virtual Color Wheel	000 - 010	White macro	RGBW channels need to are at 255 value to obtain the good color temperature. Is possible to ajust the color with RGBW
		011 - 012	Tungsten Emulation 3200°K	
		013 - 014	Tungsten Emulation 4000°K	
		015 - 016	Tungsten Emulation 4500°K	Only W channel can modify the color saturation
		017 - 250	Virtual color wheel	
		251 - 253	CW Virtual Color Wheel rotation	
254 - 255	CCW Virtual Color Wheel rotation			
14	Background Virtual Color Wheel	000 - 010	White macro	RGBW channels need to are at 255 value to obtain the good color temperature. Is possible to ajust the color with RGBW
		011 - 016	Idle	
		017 - 250	Virtual color wheel	Only W channel can modify the color saturation
		251 - 253	CW Virtual Color Wheel rotation	
		254 - 255	CCW Virtual Color Wheel rotation	
15	Colour Fade/ Speed	000 - 255	Fade between Virtual colors/ Speed from fast to slow.	

16	Pattern	000 - 009	no pattern	
		010 - 017	Pattern # 1	
		018 - 025	Pattern # 2	
		026 - 033	Pattern # 3	
		034 - 041	Pattern # 4	
		042 - 049	Pattern # 5	
		050 - 057	Pattern # 6	
		058 - 065	Pattern # 7	
		066 - 073	Pattern # 8	
		074 - 081	Pattern # 9	
		082 - 089	Pattern # 10	
		090 - 097	Pattern # 11	
		098 - 105	Pattern # 12	
		106 - 113	Pattern # 13	
		114 - 121	Pattern # 14	
		122 - 129	Pattern # 15	
		130 - 137	Pattern # 16	
		138 - 145	Pattern # 17	
		146 - 153	Pattern # 18	
		154 - 161	Pattern # 19	
		162 - 169	Pattern # 20	
		170 - 177	Pattern # 21	
		178 - 185	Pattern # 22	
		186 - 193	Pattern # 23	
		194 - 201	Pattern # 24	
		202 - 209	Pattern # 25	
		210 - 217	Pattern # 26	
		218 - 225	Pattern # 27	
		226 - 233	Pattern # 28	
		234 - 241	Pattern # 29	
242 - 249	Pattern # 30			
250 - 255	Idle			
17	Pattern Step	000	Static Step # 1	Selection of one of the 30 possible steps of the selected pattern. If the step number is empty the LEDs are OFF
		001	Static Step # 2	
		002	Static Step # 3	
		003	Static Step # 4	
		004	Static Step # 5	
		005	Static Step # 6	
		006	Static Step # 7	
		007	Static Step # 8	
		008	Static Step # 9	
		009	Static Step # 10	
		010	Static Step # 11	
		011	Static Step # 12	
		012	Static Step # 13	
		013	Static Step # 14	
		014	Static Step # 15	
		015	Static Step # 16	
		016	Static Step # 17	
		017	Static Step # 18	
		018	Static Step # 19	
		019	Static Step # 20	
		020	Static Step # 21	
		021	Static Step # 22	
		022	Static Step # 23	
		023	Static Step # 24	
		024	Static Step # 25	
		025	Static Step # 26	
		026	Static Step # 27	
		027	Static Step # 28	
		028	Static Step # 29	
		029	Static Step # 30	

17	Pattern Step	030 - 039	Idle	
		040 - 145	Chase Forward (From Fast to Slow)	
		146 - 149	Stop	
		150 - 255	Chase Backward (From Slow to Fast)	
18	Fade between steps	000	no fade	
		001 - 255	Fade from fast	
19	Zoom	000 - 255	Zoom	Narrow to Wide
20	Dim Modes	000 - 020	Default unit setting	
		021 - 040	Standard	
		041 - 060	Stage	
		061 - 080	TV	
		081 - 100	Architectural	
		101 - 255	Theatre	
21	Control	000 - 004	Idle	
		005 - 009	Invert Pan on (Hold 3s)	
		010 - 014	Invert Pan off (Hold 3s)	
		015 - 019	Invert Tilt on (Hold 3s)	
		020 - 024	Invert Tilt off (Hold 3s)	
		025 - 029	Fan Silent (Hold 3s)	The fan turn always at same low speed
		030 - 034	Fan Auto (Hold 3s)	The fan speed increase with temp
		035 - 039	Fan High (Hold 3s)	The fan turn always at same high speed
		040 - 089	Idle	
		090 - 101	Linear Dimmer Curve (hold 3s)	
		102 - 113	Square Dimmer Curve (hold 3s)	
		114 - 125	Inv - Square Dimmer Curve (hold 3s)	
		126 - 131	S - Dimmer Curve (hold 3s)	
		132 - 137	Led Freq. 900 Hz (hold 3s)	
		138 - 143	Led Freq. 1000 Hz (hold 3s)	
		144 - 149	Led Freq. 1100 Hz (hold 3s)	
		150 - 155	Led Freq. 1200 Hz (hold 3s)	
		156 - 161	Led Freq. 1300 Hz (hold 3s)	
		162 - 167	Led Freq. 1400 Hz (hold 3s)	
		168 - 173	Led Freq. 1500 Hz (hold 3s)	
		174 - 179	Led Freq. 2500 Hz (hold 3s)	
		180 - 185	Led Freq. 4000 Hz (hold 3s)	
		186 - 191	Led Freq. 5000 Hz (hold 3s)	
		192 - 197	Led Freq. 10000 Hz (hold 3s)	
		198 - 203	Led Freq. 15000 Hz (hold 3s)	
		204 - 209	Led Freq. 20000 Hz (hold 3s)	
		210 - 215	Led Freq. 25000 Hz (hold 3s)	
		216 - 218	Reset Pan/Tilt (Hold 3s)	
		219 - 221	Reset only Head (Hold 3s)	
		222 - 224	Reset All Functions (Hold 3s)	
		225 - 234	Idle	
		235 - 237	Klingnet Disable	The leds are controlled only by the dmx or Artnet
238 - 240	Leds controled Klingnet only	The leds are controlled only by the Klingnet		
241 - 243	Leds controled Klingnet + Dmx	The leds are controlled by the Klingnet but the dmx has priority over RGBW		
244 - 246	Klingnet Calibration OFF	So that the Klingnet white is matched with for example an Led screen, it is possible to calibrate it in the Modena calibration menu. This calibration can be activated or not from the console.		
247 - 249	Klingnet Calibration ON	So that the Klingnet white is matched with for example an Led screen, it is possible to calibrate it in the Modena calibration menu. This calibration can be activated or not from the console		
250 - 255	Idle			

STANDARD 16B Mode

CH	Feature	Value	Description	Information
1	Pan	000 - 255	Pan	
2	Pan fine	000 - 255		
3	Tilt	000 - 255	Tilt	
4	Tilt fine	000 - 255		
5	P/T Speed	000 - 225	Max to min speed	
		226 - 235	Blackout by movement	
		236 - 255	Idle	
6	Dimmer	000 - 255	Dimmer	
7	Dimmer Fine	000 - 255	Dimmer Fine	
8	Strobe	000 - 009	Shutter Closed	
		010 - 019	Shutter open	
		020 - 068	Strobe effect slow to fast	
		069 - 079	Shutter open	
		080 - 128	Pulse - effect in sequences	
		129 - 139	Shutter open	
		140 - 188	Random strobe effect slow to fast	
		189 - 199	Shutter open	
		200 - 248	Random flash Pixel slow to fast	
249 - 255	Shutter open			
9	Red	000 - 255	Red	
10	Red Fine	000 - 255		
11	Green	000 - 255	Green	
12	Green Fine	000 - 255		
13	Blue	000 - 255	Blue	
14	Blue Fine	000 - 255		
15	White	000 - 255	White	
16	White Fine	000 - 255		
17	Foreground Virtual Color Wheel	000 - 010	White macro	RGBW channels need to be at 255 value to obtain the good color temperature. Is possible to adjust the color with RGBW
		011 - 012	Tungsten Emulation 3200°K	
		013 - 014	Tungsten Emulation 4000°K	
		015 - 016	Tungsten Emulation 4500°K	Only W channel can modify the color saturation
		017 - 250	Virtual color wheel	
		251 - 253	CW Virtual Color Wheel rotation	
254 - 255	CCW Virtual Color Wheel rotation			
18	Background Virtual Color Wheel	000 - 010	White macro	RGBW channels need to be at 255 value to obtain the good color temperature. Is possible to adjust the color with RGBW
		011 - 016	Idle	
		017 - 250	Virtual color wheel	Only W channel can modify the color saturation
		251 - 253	CW Virtual Color Wheel rotation	
		254 - 255	CCW Virtual Color Wheel rotation	
19	Colour Fade/Speed	000 - 255	Fade between Virtual colors/ Speed from fast to slow.	

20	Pattern	000 - 009	no pattern	
		010 - 017	Pattern # 1	
		018 - 025	Pattern # 2	
		026 - 033	Pattern # 3	
		034 - 041	Pattern # 4	
		042 - 049	Pattern # 5	
		050 - 057	Pattern # 6	
		058 - 065	Pattern # 7	
		066 - 073	Pattern # 8	
		074 - 081	Pattern # 9	
		082 - 089	Pattern # 10	
		090 - 097	Pattern # 11	
		098 - 105	Pattern # 12	
		106 - 113	Pattern # 13	
		114 - 121	Pattern # 14	
		122 - 129	Pattern # 15	
		130 - 137	Pattern # 16	
		138 - 145	Pattern # 17	
		146 - 153	Pattern # 18	
		154 - 161	Pattern # 19	
		162 - 169	Pattern # 20	
		170 - 177	Pattern # 21	
		178 - 185	Pattern # 22	
		186 - 193	Pattern # 23	
		194 - 201	Pattern # 24	
		202 - 209	Pattern # 25	
		210 - 217	Pattern # 26	
		218 - 225	Pattern # 27	
		226 - 233	Pattern # 28	
		234 - 241	Pattern # 29	
242 - 249	Pattern # 30			
250 - 255	Idle			
21	Pattern Step	000	Static Step # 1	Selection of one of the 30 possible steps of the selected pattern. If the step number is empty the LEDs are OFF
		001	Static Step # 2	
		002	Static Step # 3	
		003	Static Step # 4	
		004	Static Step # 5	
		005	Static Step # 6	
		006	Static Step # 7	
		007	Static Step # 8	
		008	Static Step # 9	
		009	Static Step # 10	
		010	Static Step # 11	
		011	Static Step # 12	
		012	Static Step # 13	
		013	Static Step # 14	
		014	Static Step # 15	
		015	Static Step # 16	
		016	Static Step # 17	
		017	Static Step # 18	
		018	Static Step # 19	
		019	Static Step # 20	
		020	Static Step # 21	
		021	Static Step # 22	
		022	Static Step # 23	
		023	Static Step # 24	
		024	Static Step # 25	
		025	Static Step # 26	
		026	Static Step # 27	
		027	Static Step # 28	
		028	Static Step # 29	
		029	Static Step # 30	

21	Pattern Step	030 - 039	Idle		
		040 - 145	Chase Forward (From Fast to Slow)		
		146 - 149	Stop		
		150 - 255	Chase Backward (From Slow to Fast)		
22	Fade between steps	000	no fade		
		001 - 255	Fade from fast		
23	Zoom	000 - 255	Zoom	Narrow to Wide	
24	Dim Modes	000 - 020	Default unit setting		
		021 - 040	Standard		
		041 - 060	Stage		
		061 - 080	TV		
		081 - 100	Architectural		
		101 - 255	Theatre		
25	Control	000 - 004	Idle		
		005 - 009	Invert Pan on (Hold 3s)		
		010 - 014	Invert Pan off (Hold 3s)		
		015 - 019	Invert Tilt on (Hold 3s)		
		020 - 024	Invert Tilt off (Hold 3s)		
		025 - 029	Fan Silent (Hold 3s)		The fan turn always at same low speed
		030 - 034	Fan Auto (Hold 3s)		The fan speed increase with temp
		035 - 039	Fan High (Hold 3s)		The fan turn always at same high speed
		040 - 089	Idle		
		090 - 101	Linear Dimmer Curve (hold 3s)		
		102 - 113	Square Dimmer Curve (hold 3s)		
		114 - 125	Inv - Square Dimmer Curve (hold 3s)		
		126 - 131	S - Dimmer Curve (hold 3s)		
		132 - 137	Led Freq. 900 Hz (hold 3s)		
		138 - 143	Led Freq. 1000 Hz (hold 3s)		
		144 - 149	Led Freq. 1100 Hz (hold 3s)		
		150 - 155	Led Freq. 1200 Hz (hold 3s)		
		156 - 161	Led Freq. 1300 Hz (hold 3s)		
		162 - 167	Led Freq. 1400 Hz (hold 3s)		
		168 - 173	Led Freq. 1500 Hz (hold 3s)		
		174 - 179	Led Freq. 2500 Hz (hold 3s)		
		180 - 185	Led Freq. 4000 Hz (hold 3s)		
		186 - 191	Led Freq. 5000 Hz (hold 3s)		
		192 - 197	Led Freq. 10000 Hz (hold 3s)		
		198 - 203	Led Freq. 15000 Hz (hold 3s)		
		204 - 209	Led Freq. 20000 Hz (hold 3s)		
		210 - 215	Led Freq. 25000 Hz (hold 3s)		
		216 - 218	Reset Pan/Tilt (Hold 3s)		
		219 - 221	Reset only Head (Hold 3s)		
		222 - 224	Reset All Functions (Hold 3s)		
		225 - 234	Idle		
		235 - 237	Klingnet Disable		The leds are controlled only by the dmx or Artnet
		238 - 240	Leds controled Klingnet only		The leds are controlled only by the Klingnet
		241 - 243	Leds controled Klingnet + Dmx		The leds are controlled by the Klingnet but the dmx has priority over RGBW
244 - 246	Klingnet Calibration OFF	So that the Klingnet white is matched with for example an Led screen, it is possible to calibrate it in the Modena calibration menu. This calibration can be activated or not from the console.			
247 - 249	Klingnet Calibration ON	So that the Klingnet white is matched with for example an Led screen, it is possible to calibrate it in the Modena calibration menu. This calibration can be activated or not from the console			
250 - 255	Idle				

PIXEL 8B Mode

CH	Feature	Value	Description	Information
1	Pan	000 - 255	Pan	
2	Pan fine	000 - 255		
3	Tilt	000 - 255	Tilt	
4	Tilt fine	000 - 255		
5	P/T Speed	000 - 225	Max to min speed	
		226 - 235	Blackout by movement	
		236 - 255	Idle	
6	Dimmer	000 - 255	Dimmer	
7	Dimmer Fine	000 - 255	Dimmer Fine	
8	Strobe	000 - 009	Shutter Closed	
		010 - 019	Shutter open	
		020 - 068	Strobe effect slow to fast	
		069 - 079	Shutter open	
		080 - 128	Pulse - effect in sequences	
		129 - 139	Shutter open	
		140 - 188	Random strobe effect slow to fast	
		189 - 199	Shutter open	
		200 - 248	Random flash Pixel slow to fast	
		249 - 255	Shutter open	
9	Red	000 - 255	Red (All LEDs)	
10	Green	000 - 255	Green (All LEDs)	
11	Blue	000 - 255	Blue (All LEDs)	
12	White	000 - 255	White (All LEDs)	
13	Virtual Color Wheel	000 - 010	White macro	RGBW channels need to be at 255 value to obtain the good color temperature. Is possible to adjust the color with RGBW
		011 - 012	Tungsten Emulation 3200°K	
		013 - 014	Tungsten Emulation 4000°K	
		015 - 016	Tungsten Emulation 4500°K	Only W channel can modify the color saturation
		017 - 250	Virtual color wheel	
		251 - 253	CW Virtual Color Wheel rotation	
254 - 255	CCW Virtual Color Wheel rotation			
14	Colour Fade/ Speed	000 - 255	Fade between Virtual colors/ Speed from fast to slow.	
15	Zoom	000 - 255	Zoom	Narrow to Wide
16	Dim Modes	000 - 020	Default unit setting	
		021 - 040	Standard	
		041 - 060	Stage	
		061 - 080	TV	
		081 - 100	Architectural	
		101 - 255	Theatre	

17	Control	000 - 004	Idle	
		005 - 009	Invert Pan on (Hold 3s)	
		010 - 014	Invert Pan off (Hold 3s)	
		015 - 019	Invert Tilt on (Hold 3s)	
		020 - 024	Invert Tilt off (Hold 3s)	
		025 - 029	Fan Silent (Hold 3s)	The fan turn always at same low speed
		030 - 034	Fan Auto (Hold 3s)	The fan speed increase with temp
		035 - 039	Fan High (Hold 3s)	The fan turn always at same high speed
		040 - 089	Idle	
		090 - 101	Linear Dimmer Curve (hold 3s)	
		102 - 113	Square Dimmer Curve (hold 3s)	
		114 - 125	Inv - Square Dimmer Curve (hold 3s)	
		126 - 131	S - Dimmer Curve (hold 3s)	
		132 - 137	Led Freq. 900 Hz (hold 3s)	
		138 - 143	Led Freq. 1000 Hz (hold 3s)	
		144 - 149	Led Freq. 1100 Hz (hold 3s)	
		150 - 155	Led Freq. 1200 Hz (hold 3s)	
		156 - 161	Led Freq. 1300 Hz (hold 3s)	
		162 - 167	Led Freq. 1400 Hz (hold 3s)	
		168 - 173	Led Freq. 1500 Hz (hold 3s)	
		174 - 179	Led Freq. 2500 Hz (hold 3s)	
		180 - 185	Led Freq. 4000 Hz (hold 3s)	
		186 - 191	Led Freq. 5000 Hz (hold 3s)	
		192 - 197	Led Freq. 10000 Hz (hold 3s)	
		198 - 203	Led Freq. 15000 Hz (hold 3s)	
		204 - 209	Led Freq. 20000 Hz (hold 3s)	
		210 - 215	Led Freq. 25000 Hz (hold 3s)	
		216 - 218	Reset Pan/Tilt (Hold 3s)	
		219 - 221	Reset only Head (Hold 3s)	
		222 - 224	Reset All Functions (Hold 3s)	
		225 - 234	Idle	
		235 - 237	Klingnet Disable	The leds are controlled only by the dmx or Artnet
		238 - 240	Leds controled Klingnet only	The leds are controlled only by the Klingnet
241 - 243	Leds controled Klingnet + Dmx	The leds are controlled by the Klingnet but the dmx has priority over RGBW		
244 - 246	Klingnet Calibration OFF	So that the Klingnet white is matched with for example an Led screen, it is possible to calibrate it in the Modena calibration menu. This calibration can be activated or not from the console.		
247 - 249	Klingnet Calibration ON	So that the Klingnet white is matched with for example an Led screen, it is possible to calibrate it in the Modena calibration menu. This calibration can be activated or not from the console		
250 - 255	Idle			

18	Red	000 - 255	Pixel #1
19	Green	000 - 255	
20	Blue	000 - 255	
21	White	000 - 255	
22	Red	000 - 255	Pixel #2
23	Green	000 - 255	
24	Blue	000 - 255	
25	White	000 - 255	
26	Red	000 - 255	Pixel #3
27	Green	000 - 255	
28	Blue	000 - 255	
29	White	000 - 255	
30	Red	000 - 255	Pixel #4
31	Green	000 - 255	
32	Blue	000 - 255	
33	White	000 - 255	
34	Red	000 - 255	Pixel #5
35	Green	000 - 255	
36	Blue	000 - 255	
37	White	000 - 255	
38	Red	000 - 255	Pixel #6
39	Green	000 - 255	
40	Blue	000 - 255	
41	White	000 - 255	
42	Red	000 - 255	Pixel #7
43	Green	000 - 255	
44	Blue	000 - 255	
45	White	000 - 255	
46	Red	000 - 255	Pixel #8
47	Green	000 - 255	
48	Blue	000 - 255	
49	White	000 - 255	
50	Red	000 - 255	Pixel #9
51	Green	000 - 255	
52	Blue	000 - 255	
53	White	000 - 255	
54	Red	000 - 255	Pixel #10
55	Green	000 - 255	
56	Blue	000 - 255	
57	White	000 - 255	
58	Red	000 - 255	Pixel #11
59	Green	000 - 255	
60	Blue	000 - 255	
61	White	000 - 255	
62	Red	000 - 255	Pixel #12
63	Green	000 - 255	
64	Blue	000 - 255	
65	White	000 - 255	

66	Red	000 - 255	Pixel #13
67	Green	000 - 255	
68	Blue	000 - 255	
69	White	000 - 255	
70	Red	000 - 255	Pixel #14
71	Green	000 - 255	
72	Blue	000 - 255	
73	White	000 - 255	
74	Red	000 - 255	Pixel #15
75	Green	000 - 255	
76	Blue	000 - 255	
77	White	000 - 255	
78	Red	000 - 255	Pixel #16
79	Green	000 - 255	
80	Blue	000 - 255	
81	White	000 - 255	
82	Red	000 - 255	Pixel #17
83	Green	000 - 255	
84	Blue	000 - 255	
85	White	000 - 255	
86	Red	000 - 255	Pixel #18
87	Green	000 - 255	
88	Blue	000 - 255	
89	White	000 - 255	
90	Red	000 - 255	Pixel #19
91	Green	000 - 255	
92	Blue	000 - 255	
93	White	000 - 255	



PIXEL 16B Mode

CH	Feature	Value	Description	Information
1	Pan	000 - 255	Pan	
2	Pan fine	000 - 255		
3	Tilt	000 - 255	Tilt	
4	Tilt fine	000 - 255		
5	P/T Speed	000 - 225	Max to min speed	
		226 - 235	Blackout by movement	
		236 - 255	Idle	
6	Dimmer	000 - 255	Dimmer	
7	Dimmer Fine	000 - 255	Dimmer Fine	
8	Strobe	000 - 009	Shutter Closed	
		010 - 019	Shutter open	
		020 - 068	Strobe effect slow to fast	
		069 - 079	Shutter open	
		080 - 128	Pulse - effect in sequences	
		129 - 139	Shutter open	
		140 - 188	Random strobe effect slow to fast	
		189 - 199	Shutter open	
		200 - 248	Random flash Pixel slow to fast	
249 - 255	Shutter open			
9	Zoom	000 - 255	Zoom	Narrow to Wide
10	Dim Modes	000 - 020	Default unit setting	
		021 - 040	Standard	
		041 - 060	Stage	
		061 - 080	TV	
		081 - 100	Architectural	
		101 - 255	Theatre	
11	Control	000 - 004	Idle	
		005 - 009	Invert Pan on (Hold 3s)	
		010 - 014	Invert Pan off (Hold 3s)	
		015 - 019	Invert Tilt on (Hold 3s)	
		020 - 024	Invert Tilt off (Hold 3s)	
		025 - 029	Fan Silent (Hold 3s)	The fan turn always at same low speed
		030 - 034	Fan Auto (Hold 3s)	The fan speed increase with temp
		035 - 039	Fan High (Hold 3s)	The fan turn always at same high speed
		040 - 089	Idle	
		090 - 101	Linear Dimmer Curve (hold 3s)	
		102 - 113	Square Dimmer Curve (hold 3s)	
		114 - 125	Inv - Square Dimmer Curve (hold 3s)	
		126 - 131	S - Dimmer Curve (hold 3s)	
		132 - 137	Led Freq. 900 Hz (hold 3s)	
		138 - 143	Led Freq. 1000 Hz (hold 3s)	
		144 - 149	Led Freq. 1100 Hz (hold 3s)	
		150 - 155	Led Freq. 1200 Hz (hold 3s)	
		156 - 161	Led Freq. 1300 Hz (hold 3s)	
		162 - 167	Led Freq. 1400 Hz (hold 3s)	
		168 - 173	Led Freq. 1500 Hz (hold 3s)	
		174 - 179	Led Freq. 2500 Hz (hold 3s)	
		180 - 185	Led Freq. 4000 Hz (hold 3s)	
		186 - 191	Led Freq. 5000 Hz (hold 3s)	
		192 - 197	Led Freq. 10000 Hz (hold 3s)	
		198 - 203	Led Freq. 15000 Hz (hold 3s)	
		204 - 209	Led Freq. 20000 Hz (hold 3s)	
		210 - 215	Led Freq. 25000 Hz (hold 3s)	
		216 - 218	Reset Pan/Tilt (Hold 3s)	
		219 - 221	Reset only Head (Hold 3s)	
		222 - 224	Reset All Functions (Hold 3s)	
225 - 234	Idle			

11	Control	235 - 237	Klingnet Disable	The leds are controlled only by the dmx or Artnet
		238 - 240	Leds controled Klingnet only	The leds are controlled only by the Klingnet
		241 - 243	Leds controled Klingnet + Dmx	The leds are controlled by the Klingnet but the dmx has priority over RGBW
		244 - 246	Klingnet Calibration OFF	So that the Klingnet white is matched with for example an Led screen, it is possible to calibrate it in the Modena calibration menu. This calibration can be activated or not from the console.
		247 - 249	Klingnet Calibration ON	So that the Klingnet white is matched with for example an Led screen, it is possible to calibrate it in the Modena calibration menu. This calibration can be activated or not from the console
		250 - 255	Idle	
12	Red	000 - 255	Pixel #1	
13	Red Fine	000 - 255		
14	Green	000 - 255		
15	Green Fine	000 - 255		
16	Blue	000 - 255		
17	Blue Fine	000 - 255		
18	White	000 - 255		
19	White Fine	000 - 255	Pixel #2	
20	Red	000 - 255		
21	Red Fine	000 - 255		
22	Green	000 - 255		
23	Green Fine	000 - 255		
24	Blue	000 - 255		
25	Blue Fine	000 - 255		
26	White	000 - 255	Pixel #3	
27	White Fine	000 - 255		
28	Red	000 - 255		
29	Red Fine	000 - 255		
30	Green	000 - 255		
31	Green Fine	000 - 255		
32	Blue	000 - 255		
33	Blue Fine	000 - 255	Pixel #4	
34	White	000 - 255		
35	White Fine	000 - 255		
36	Red	000 - 255		
37	Red Fine	000 - 255		
38	Green	000 - 255		
39	Green Fine	000 - 255		
40	Blue	000 - 255	Pixel #5	
41	Blue Fine	000 - 255		
42	White	000 - 255		
43	White Fine	000 - 255		
44	Red	000 - 255		
45	Red Fine	000 - 255		
46	Green	000 - 255		
47	Green Fine	000 - 255	Pixel #5	
48	Blue	000 - 255		
49	Blue Fine	000 - 255		
50	White	000 - 255		
51	White Fine	000 - 255		

52	Red	000 - 255	Pixel #6
53	Red Fine	000 - 255	
54	Green	000 - 255	
55	Green Fine	000 - 255	
56	Blue	000 - 255	
57	Blue Fine	000 - 255	
58	White	000 - 255	
59	White Fine	000 - 255	
60	Red	000 - 255	Pixel #7
61	Red Fine	000 - 255	
62	Green	000 - 255	
63	Green Fine	000 - 255	
64	Blue	000 - 255	
65	Blue Fine	000 - 255	
66	White	000 - 255	
67	White Fine	000 - 255	
68	Red	000 - 255	Pixel #8
69	Red Fine	000 - 255	
70	Green	000 - 255	
71	Green Fine	000 - 255	
72	Blue	000 - 255	
73	Blue Fine	000 - 255	
74	White	000 - 255	
75	White Fine	000 - 255	
76	Red	000 - 255	Pixel #9
77	Red Fine	000 - 255	
78	Green	000 - 255	
79	Green Fine	000 - 255	
80	Blue	000 - 255	
81	Blue Fine	000 - 255	
82	White	000 - 255	
83	White Fine	000 - 255	
84	Red	000 - 255	Pixel #10
85	Red Fine	000 - 255	
86	Green	000 - 255	
87	Green Fine	000 - 255	
88	Blue	000 - 255	
89	Blue Fine	000 - 255	
90	White	000 - 255	
91	White Fine	000 - 255	
92	Red	000 - 255	Pixel #11
93	Red Fine	000 - 255	
94	Green	000 - 255	
95	Green Fine	000 - 255	
96	Blue	000 - 255	
97	Blue Fine	000 - 255	
98	White	000 - 255	
99	White Fine	000 - 255	
100	Red	000 - 255	Pixel #12
101	Red Fine	000 - 255	
102	Green	000 - 255	
103	Green Fine	000 - 255	
104	Blue	000 - 255	
105	Blue Fine	000 - 255	
106	White	000 - 255	
107	White Fine	000 - 255	

108	Red	000 - 255	Pixel #13
109	Red Fine	000 - 255	
110	Green	000 - 255	
111	Green Fine	000 - 255	
112	Blue	000 - 255	
113	Blue Fine	000 - 255	
114	White	000 - 255	
115	White Fine	000 - 255	
116	Red	000 - 255	Pixel #14
117	Red Fine	000 - 255	
118	Green	000 - 255	
119	Green Fine	000 - 255	
120	Blue	000 - 255	
121	Blue Fine	000 - 255	
122	White	000 - 255	
123	White Fine	000 - 255	
124	Red	000 - 255	Pixel #15
125	Red Fine	000 - 255	
126	Green	000 - 255	
127	Green Fine	000 - 255	
128	Blue	000 - 255	
129	Blue Fine	000 - 255	
130	White	000 - 255	
131	White Fine	000 - 255	
132	Red	000 - 255	Pixel #16
133	Red Fine	000 - 255	
134	Green	000 - 255	
135	Green Fine	000 - 255	
136	Blue	000 - 255	
137	Blue Fine	000 - 255	
138	White	000 - 255	
139	White Fine	000 - 255	
140	Red	000 - 255	Pixel #17
141	Red Fine	000 - 255	
142	Green	000 - 255	
143	Green Fine	000 - 255	
144	Blue	000 - 255	
145	Blue Fine	000 - 255	
146	White	000 - 255	
147	White Fine	000 - 255	
148	Red	000 - 255	Pixel #18
149	Red Fine	000 - 255	
150	Green	000 - 255	
151	Green Fine	000 - 255	
152	Blue	000 - 255	
153	Blue Fine	000 - 255	
154	White	000 - 255	
155	White Fine	000 - 255	
156	Red	000 - 255	Pixel #19
157	Red Fine	000 - 255	
158	Green	000 - 255	
159	Green Fine	000 - 255	
160	Blue	000 - 255	
161	Blue Fine	000 - 255	
162	White	000 - 255	
163	White Fine	000 - 255	

Pattern #1

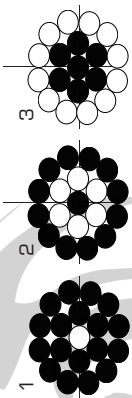

Pattern #2

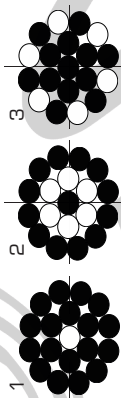

Pattern #3

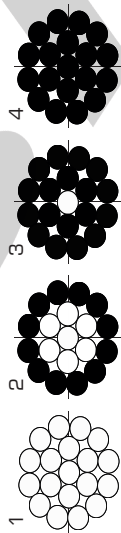

Pattern #4

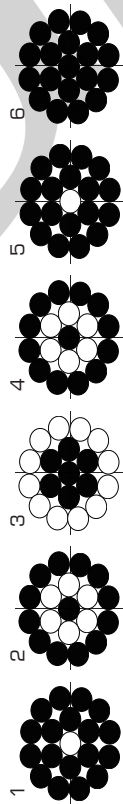

Pattern #5

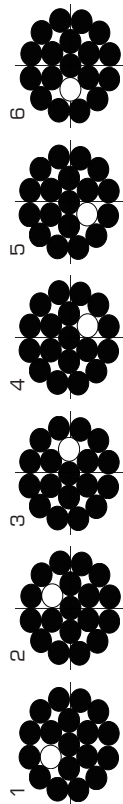

Pattern #6

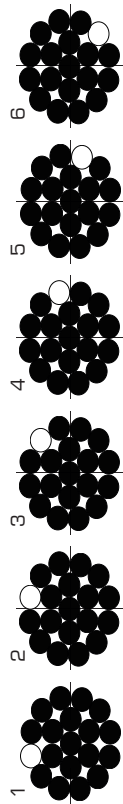

Pattern #7

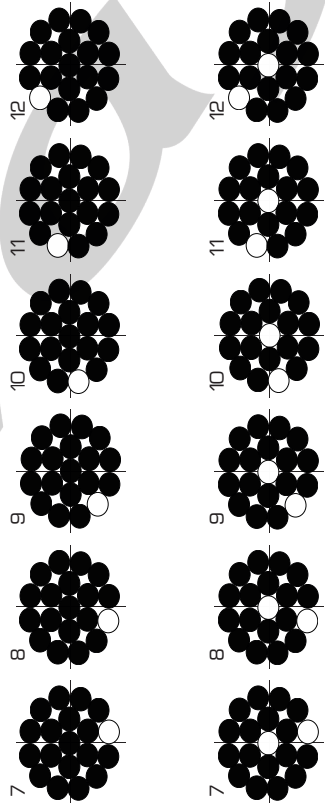
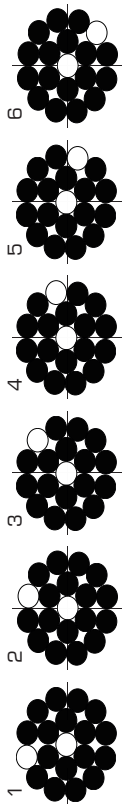

Pattern #8

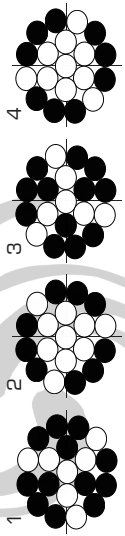

Pattern #9

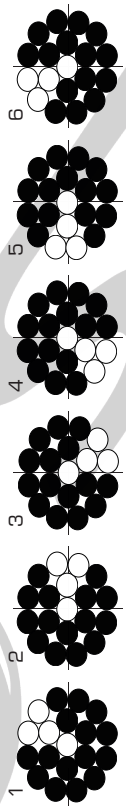

Pattern #10

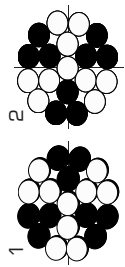

Pattern #11

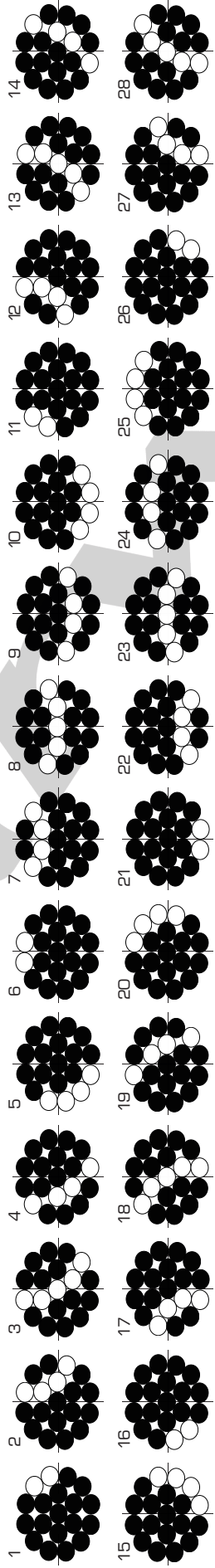

Pattern #12

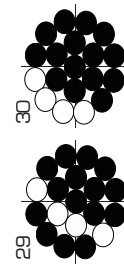
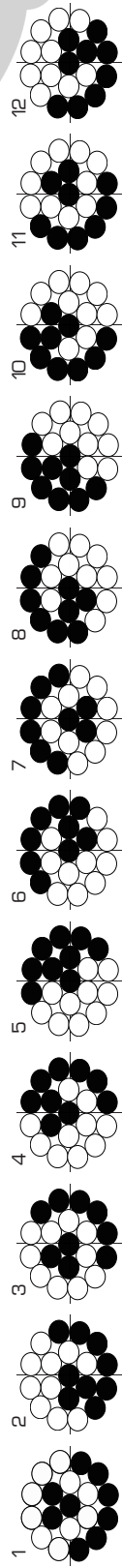

Pattern #12

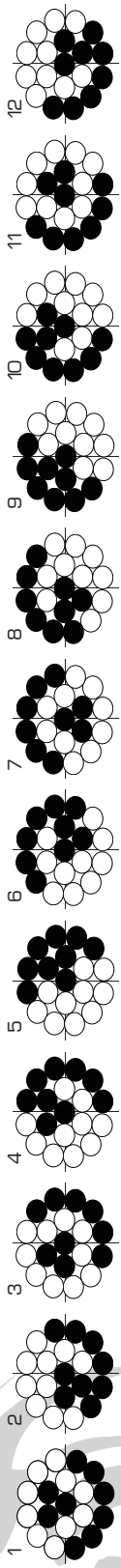

Pattern #13

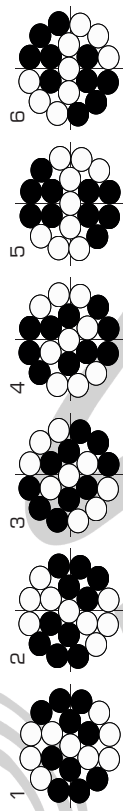

Pattern #14



Pattern #15

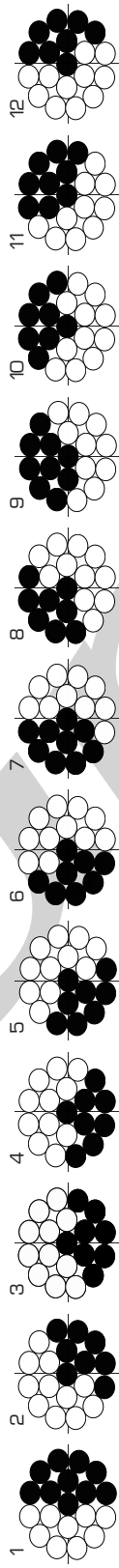

Pattern #16

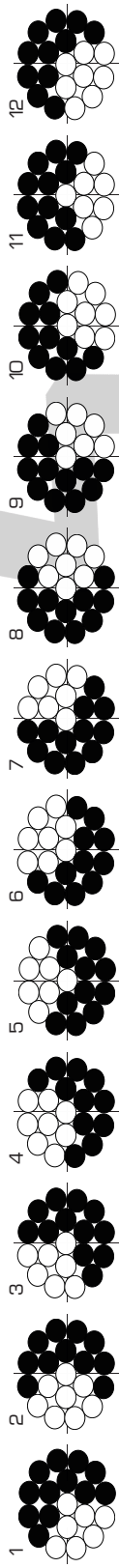

Pattern #17

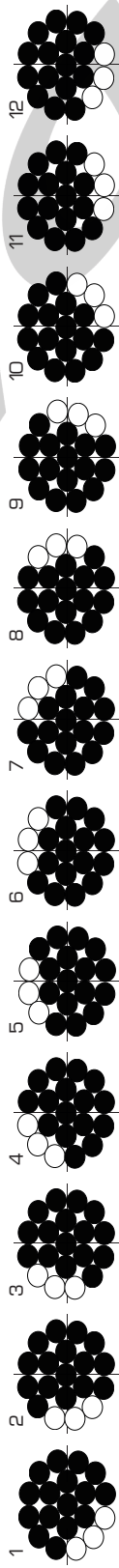

Pattern #18

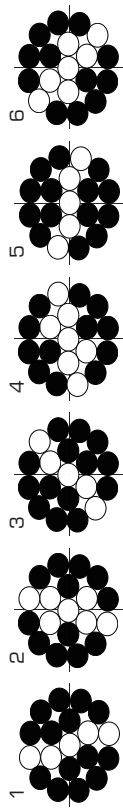

Pattern #19

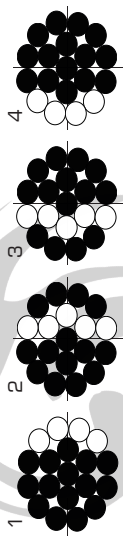

Pattern #20

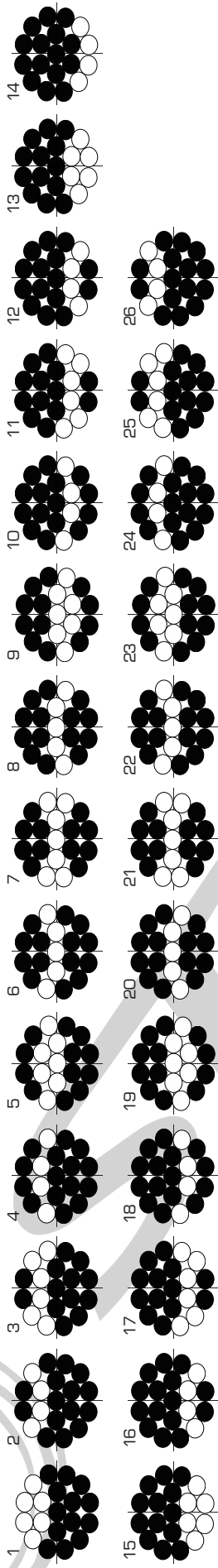

Pattern #21

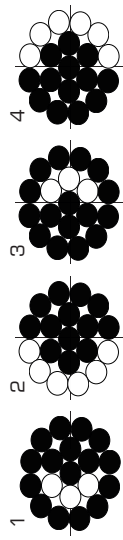

Pattern #22

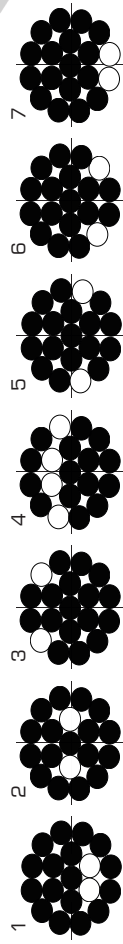

Pattern #23

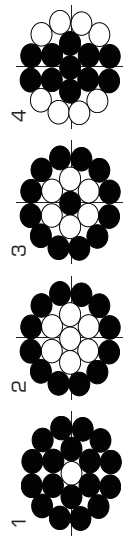

Pattern #24

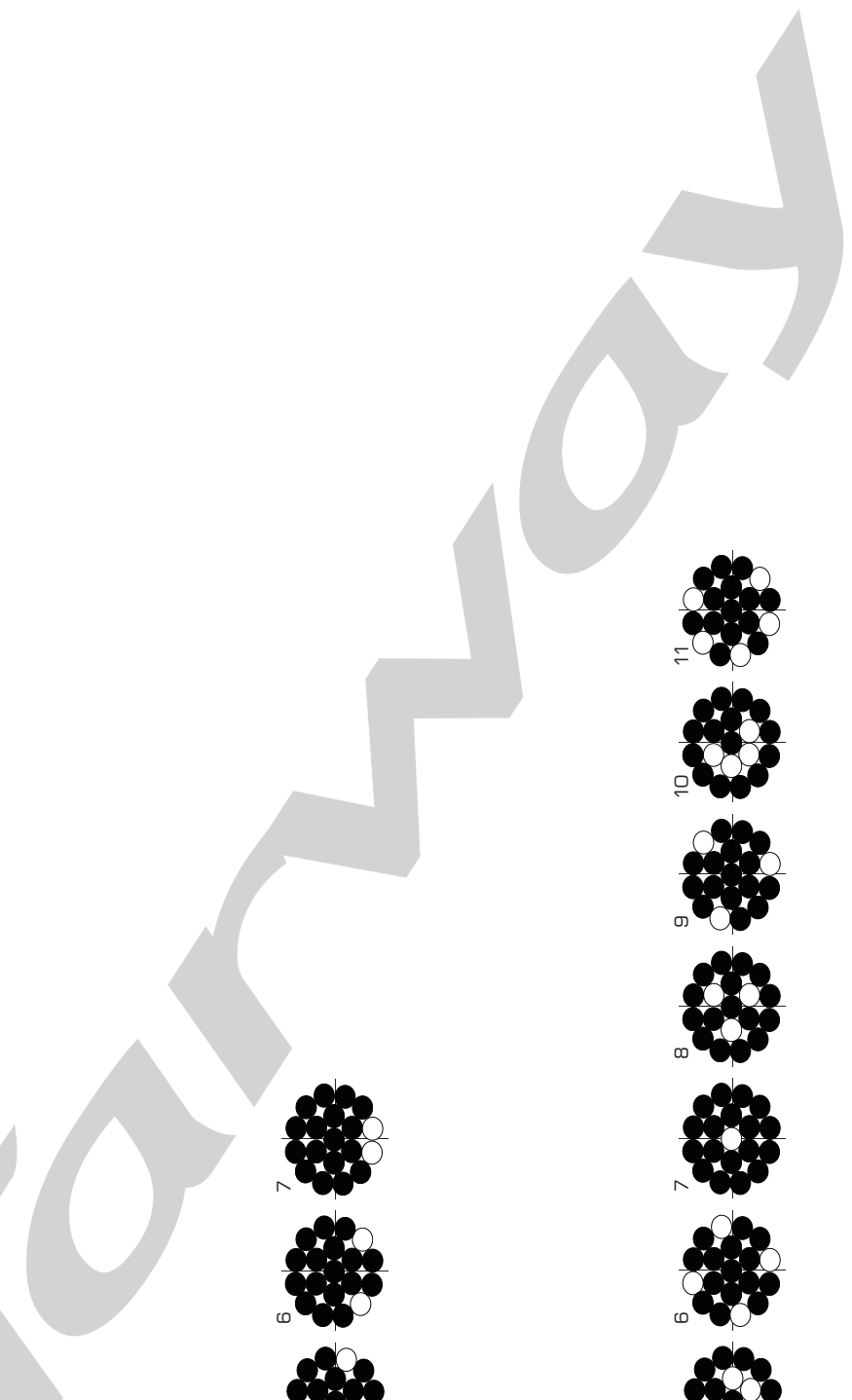
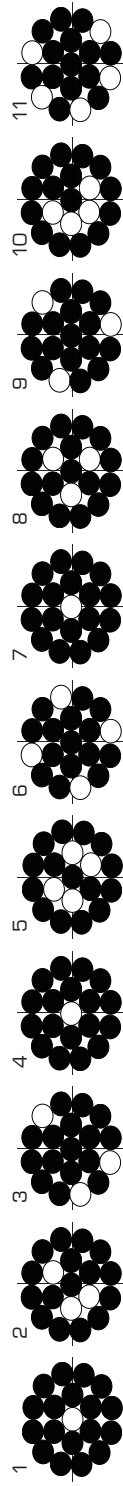

Pattern #25

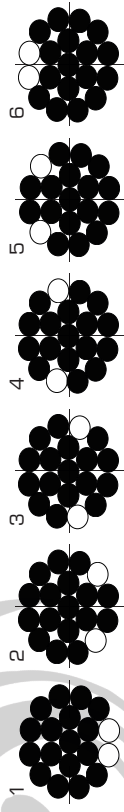

Pattern #26

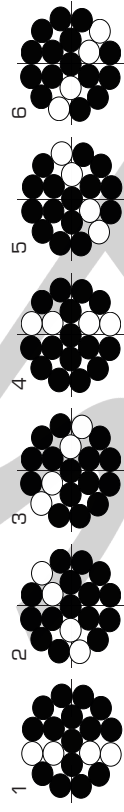

Pattern #27

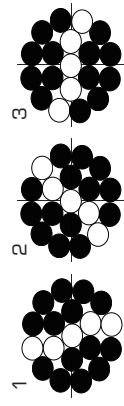

Pattern #28

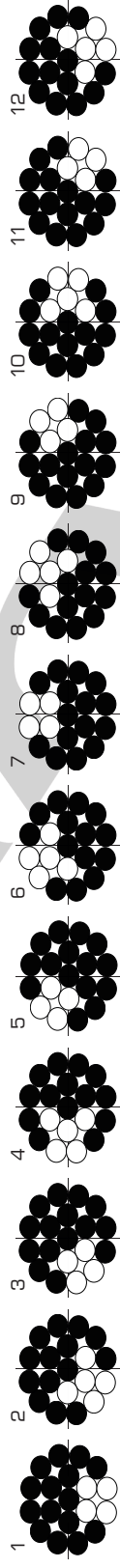

Pattern #29

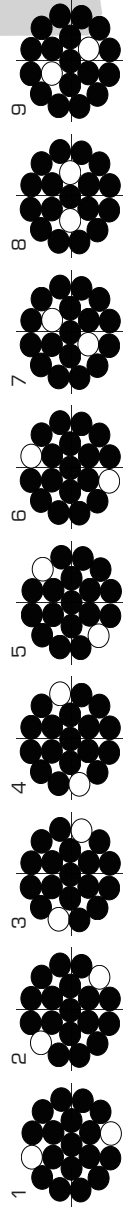

Pattern #30

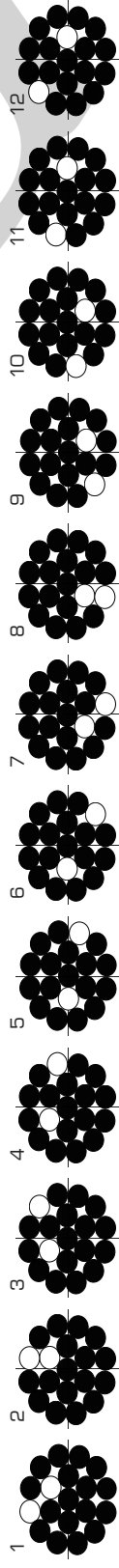

STARWAY

22 Rue Edouard Buffard
77144 MONTEVRAIN
France
Tél. : +33 (0)820 230 007

